



# **2025 Catalog**

## **Commercial Growers Guide**

**Agriculture Chemicals**

**Fertilizer**

**Organic Products**

**Greenhouse Supplies**

**Farm Supplies**

**Equipment**

**Irrigation**



# Making good growing better



## **Better Ingredients, Better Products, Better Results**

Nature Safe Organic Fertilizers feed the soil with Nitrogen and essential micronutrients which are readily available to meet your crops growth needs. Application flexibility at planting and during growing season. Use alone or to enhance your current fertilizer program.

- . Fertilizers are safety and quality tested
- . Nutrient release curves support plant and soil needs
- . Boosts organic and conventional fertilizer programs
- . Increase yield, quality and ROI
- . Readily available products from our production plants

Visit [naturesafe.com](http://naturesafe.com) to view our full line of Ag & Turf products.

**For all your Nature Safe needs, contact  
Progressive Growers at 508-273-7358.**

**13-0-0 Pelleted Fertilizer  
For Organic Production**

**10-2-8 Coarse  
All Season Fertilizer**

**Available in bags, totes,  
or bulk**



# Index

**A**  
 Adjuvants – Conventional.....3  
 Adjuvants – Organic.....16  
 Alarms/Sirens.....51  
 Azomite.....16

**B**  
 BCS Equipment.....20-21  
 Bactericides – Conventional.....3 - 4  
 Baskets/Bins/Boxes.....96–98  
 Berry Boxes.....99  
 Bulb Planter.....37

**C**  
 Camlocks.....83  
 Circulation Fans.....48  
 Compost.....105,107-108  
 Cover Crops.....19  
 Cranks.....55  
 Crop Cover.....111

**D**  
 Decorative Planters.....68  
 Dramm.....95  
 Drip Tape.....77  
 Drip Tape Fittings/Tools.....78-79

**E**  
 Extrusions.....44  
 Extension Hangers.....45

**F**  
 Fertilizer – Conventional.....7  
 Fertilizer – Organic.....11–16  
 Fertilizer Injectors .....72-74  
 Fertrell Products.....15  
 Filters .....86  
 Flower Pouches .....71  
 Foggers .....40  
 Forage Seed .....19  
 Fungicide – Organic.....11  
 Fungicides – Conventional.....3 - 4

**G**  
 Greenhouse Benches.....50  
 Greenhouse Doors.....47  
 Greenhouse Irrigation.....88  
 Greenhouse Fans.....48  
 Greenhouse Hardware.....44-46  
 Greenhouse Heaters.....49  
 Greenhouse Plastic.....42  
 Greenhouse Shutters .....48  
 Greenhouse Sprayer.....40  
 Greenhouse Structures.....51-54

**H**  
 Hand Tools.....100  
 Hanging Baskets.....65  
 Harvest Conveyor.....35  
 Heat Mats.....56  
 Herbicide – Organic.....11  
 Herbicides – Conventional.....4  
 Hose Adapters.....94  
 Humidity Domes.....64  
 Hydrants.....82

**I**  
 Inflation Blowers.....43  
 Insert Packs.....57  
 Insert Fittings.....80-81  
 Insect Netting.....114  
 Insecticide – Organic.....11  
 Insecticides – Conventional.....5  
 Irrigation Controllers.....84

**J**  
 Jiffy Strips.....63  
 Jang Seeder.....36

**K**  
 Kreher’s Fertilizer.....11  
 King’s.....19

**L**  
 Layflat Hose.....75

**M**  
 Masterblend.....9  
 Measuring Pitchers.....102  
 Media Master.....38  
 Miticide – Conventional.....5  
 Mulch Layer.....25–26, 28-29  
 Mulch Lifter.....27  
 Mulch Wrapper.....27

**N**  
 Nature Safe Fertilizer.....15  
 Neptune’s Harvest.....13  
 Nitrogen.....16  
 Nursery Carts/Racks.....56  
 Nursery Containers.....62

**O**  
 Orchard Tubing.....76  
 Oval Hose.....75

**P**  
 Perlite.....109  
 Phosphorus.....16  
 Plant Labels.....71  
 Planters.....30  
 Plant Growth Regulators.....5  
 Plant Sleeves.....64  
 Plastic Mulch.....111  
 Plug Sheets/Trays.....59  
 Polycarbonate Sheeting.....44  
 Potassium.....16  
 Pots/Trays, Round .....61  
 Pots/Trays, Square.....60  
 PPE.....41  
 Pressure Regulators.....85  
 Pumps.....87

**R**  
 Row Cover.....113  
 Rubber Bands.....98

**S**  
 Sch80 Fittings.....81  
 Seed Inoculant.....19  
 Seeders.....36  
 Seeder Spreader 20 LB.....36  
 Silage Sheet.....111  
 Shade Cloth.....42  
 Sheet of Pots.....60  
 Solu-Cal.....7  
 Soluble Fertilizer.....9  
 Soil.....103-110  
 Soil Amendments – Conventional.....7  
 Sprayers.....39  
 Sundown Equipment.....33-34  
 Sun-gro.....103  
 Sundstrom Masks.....41

**T**  
 Thermostats.....51  
 Tomato Cages/Hooks.....101  
 Tomato Stakes.....102  
 Transplanter.....22-24,30-32  
 Tractor Attachments.....21  
 Tractors, BCS.....20  
 Trays/Flats.....58  
 Twine.....102

**V - Z**  
 Vermiculite.....109  
 Vermont Compost.....105  
 Vine Clips .....102  
 Water Breakers.....95  
 Water Wheel Transplanters.....22–24  
 Wax Boxes.....98  
 Wirelock .....43  
 Wobblers.....93  
 Zig Zag (Wiggle) Wire .....43

## QUICK FIND

<b>AGRICULTURAL CHEMICALS</b>	<b>3-5</b>
<b>COVER CROPS</b>	<b>17</b>
<b>CROP COVER</b>	<b>111</b>
<b>EQUIPMENT</b>	<b>20-38</b>
<b>FARM SUPPLIES</b>	<b>96</b>
<b>FERTILIZER</b>	<b>7-9</b>
<b>GREENHOUSE SUPPLIES</b>	<b>42-56</b>
<b>IRRIGATION</b>	<b>72</b>
<b>ORGANIC PRODUCTS</b>	<b>11-17</b>
<b>POTS/TRAYS</b>	<b>57</b>
<b>SOIL</b>	<b>103-110</b>



# Thank You for Shopping Progressive Grower!

We encourage you to submit your orders two weeks before pickup or ship date to allow us time to process and pack your order. We reserve the right to pro-rate any items in short supply. Please pick up orders no later than the month after ordering. Orders left after 30 days will be subject to available supply and price.

Upon receiving your order please inspect it immediately and report any error, shortage, or damage within 3 days. Progressive Grower is not responsible for shortages reported more than 3 days after receipt.

Returns: Saleable products may be returned with permission and may be subject to handling charges based on the condition and time of return for seasonal products. Expired products, fertilizers, seeds, special order, and non-stock items are not returnable.

Credit Invoices: In the case of overpayments, cancellations, shortages, returns, defective products, etc. credit invoices will be issued. Credit invoices not used will be mailed annually.

All prices are FOB West Wareham, MA or Riverhead, NY (except items with indicated FOB point) and are subject to change without notice.

*Contact us for pricing discounts on large quantity orders.*

## 2026 PRE-ORDER GUIDE

Please keep in mind that some items should be ordered early to ensure you get them in a timely manner. Also, some items are in short supply or can only be brought in once or twice a year. Please review the following list and consider placing your order today.

### TERMS

Credit Card or Check in Advance.



### SHIPPING OPTIONS



Truckload



LTL



Partial TL



We also offer UPS Next Day Air and other expedited shipping options. When Shipping LTL motor freight we compare prices among numerous carriers to find the best rates. Progressive Grower trucks deliver in New England and New York. We will ship your order in the most economical way possible.

**Prices in this catalog are subject to change without notice. We are not responsible for typos.**

## A Letter to Our Customers

We really appreciate your business and hope that our service meets your expectations. Since 2020 we have seen a myriad of challenges in our industry. For 2025, we are expecting fertilizer pricing to continue to rise, as well as most of your other needed supplies, to be on the increase. We encourage you to use this catalog as a handbook for placing your orders with the understanding that stock availability is ever-changing and the prices may change with no notice. As always, we will need as much notice as possible to prepare orders and schedule deliveries. We encourage you to order prior to the end of the year for the best pricing.

If you have any questions about inventory or prices, please contact us at **508-273-7358** or [info@progressivegrower.com](mailto:info@progressivegrower.com).

Sincerely,

All of us at Progressive Grower



# AGRICULTURAL CHEMICALS



We refrain from shipping products to states where they are not registered. For pricing inquiries, kindly reach out to us. We also offer additional products; feel free to contact us if you are searching for items not currently listed.

## Adjuvents

ITEM	DESCRIPTION	SIZE
15482	AQUIFLO	2.5 GAL
12056	CHEM STIK LPH	2.5 GAL
12205	FOME-KIL	1 QT
12285	FOME-KIL	GAL
3989	FS AMS MAX SURFACTANT	2.5 GAL
11711	FS AQUALIGHT NIS 80/20	2.5 GAL
14377	FS AQUASUPREME 2.0 NIS 90/10	GAL
465	FS AQUASUPREME 2.0 NIS 90/10	2.5 GAL
2605	FS BARRIER-DRIFT RETARDANT	1 QT
2357	FS COC SUPREME CROP OIL	2.5 GAL
467	FS CROPSTIK SPREADER - STICKER	1 GAL
3606	FS MSO ULTRA	2.5 GAL
13179	FS TASK SPREADER BUFFER	2.5 GAL
3122	SPEED ORGANOSILICONE SURFACTANT	1 GAL
1539	SUPER SIGNAL BLUE DYE	1 QT
1578	SUPER SIGNAL BLUE DYE	2.5 GAL
4980	TRANSPORT ULTRA WATER CONDITIONER/NIS	2.5 GAL
10844	X-MARK FOAM CONCENTRATE	1 GAL

## Fungicides / Bactericides

ITEM	DESCRIPTION	SIZE
3053	ACTIGARD 50 WG PLANT ACTIVATOR	8 OZ
12204	AFRAME (AZOXYSTROBIN)	2.5 GAL
12903	AGRI-MYCIN 50	3 LB
12168	APPROVIA TOP	1 GAL
10743	APROVIA	1 GAL
4123	BADGE SC	2.5 GAL
5155	BRAVO WEATHERSTICK	2.5 GAL
5156	BRAVO ULTREX	27.4 LB
2486	CABRIO EG	5 LB
1652	CAPTAN 4L	2.5 GAL
2327	CAPTAN 80WDG	6.25 LB
2382	CAPTAN 80WDG	30 LB

## Fungicides / Bactericides Cont.

ITEM	DESCRIPTION	SIZE
14255	CEVYA	100 OZ
5015	CUPROFIX	30 LB
2379	ELEVATE 50 WDG	2 LB
15994	FIREWALL 50WP	5 LB
12284	FLINT® EXTRA	32 OZ
2635	FONTELIS	80 OZ
14908	FUNGI-PHITE	2.5 GAL
5153	INDAR 2F	1 GAL
2458	INSPIRE SUPER	1 GAL
3572	LIME SULFUR SOLUTION (MILLER)	5 GAL
10791	LUNA EXPERIENCE	64 OZ
21-0450	LUNA SENSATION	64 OZ
3529	MANZATE MAX	2.5 GAL
2380	MANZATE PROSTICK	6 LB
428	MANZATE PROSTICK	30 LB
13213	MERIVON XEMMIUM SC	55 OZ
12070	METTLE 125ME	30 OZ
4929	METTLE 125ME	1 GAL
3029	MICROTHIOL DISPERSS SULFUR	30 LB
15201	MIRAVIS PRIME - NY RUP	2.5 GAL
2485	MYCOSHIELD	2 LB
3586	NUTROL	50 LB
13124	ORONDIS ULTRA	1 GAL
497	OXIDATE 2.0	2.5 GAL
12974	OXIDATE 2.0	5 GAL
14814	OXIDATE 2.0	30 GAL
10939	OX-PHOS	2.5 GAL
4780	PENNCOZEB 75DF	30 LB
3604	PH-D WDG	2 LB
2549	PRESIDIO	1 QT
2404	PREVICUR FLEX	2.5 GAL
2333	PRISTINE	120 OZ
3063	PROLINE 480 SC	2.5 GAL
3074	QUADRI TOP	2.5 GAL
2449	QUINTEC	30 OZ
2407	RALLY 40WSP	20 OZ



# AGRICULTURAL CHEMICALS

## Fungicides / Bactericides Cont.

ITEM	DESCRIPTION	SIZE
2603	RANMAN 400 SC	1 QT
4096	RANMAN 400 SC	1 GAL
2600	REVUS TOP	2.5 GAL
2489	RIDOMIL GOLD BRAVO - MA RUP	2.5 GAL
2548	RIDOMIL GOLD MZ	5 LB
2960	RIDOMIL GOLD SL	1 PT
468	RIDOMIL GOLD SL	1 GAL
14358	SANIDATE 5.0	2.5 GAL
3088	SANIDATE 5.0	5 GAL
13169	SANIDATE 5.0	55 GAL
15867	SANIDATE 12.0	5 GAL
2520	SCALA SC	64 OZ
12304	SOVRAN - NY/MA RUP	20 OZ
2381	SWITCH 62.5WG	28 OZ
3679	SYLLIT	2.5 GAL
2490	TANOS	7.5 LB
2353	T-METHYL 4.5FL	2.5 GAL
2352	TOPSIN M WSB	5 LB
2606	TORINO - MA RUP	34 OZ
2962	VANGARD WG	50 OZ
4979	VIVANDO SC	1 GAL
4978	ZAMPRO	140 OZ
2498	ZEROTOL 2.0	2.5 GAL
15599	ZIRAM XCEL	6 LB

## Herbicides

ITEM	DESCRIPTION	SIZE
4909	ACCENT Q	18 OZ
10424	ACURON - RUP	2.5 GAL
2873	ALION	1 QT
2952	ATRAZINE 4L - RUP	2.5 GAL
3879	ATRAZINE 90DF - RUP	25 LB
2406	BASAGRAN	2.5 GAL
2378	BICEP II MAGNUM - RUP	2.5 GAL
2248	BULLZEYE (GLYPHOSATE)	2.5 GAL
2665	BULLZEYE (GLYPHOSATE)	30 GAL
463	CASORON 4G COURSE GRADE	50 LB
15017	CERIDIAN 2EC (CLETHODIM)	2.5 GAL
4479	CHATEAU WS	2.5 LB
4977	CLETHODIM 2EC	1 GAL
2373	COMMAND 3ME	2.5 GAL

## Herbicides Cont.

ITEM	DESCRIPTION	SIZE
5107	CROSSBOW - MA RUP	1 GAL
5144	CROSSBOW - MA RUP	2.5 GAL
2642	CURBIT EC	2.5 GAL
10327	CUTRINE PLUS	2.5 GAL
16007	CUTRINE PLUS GRANULES	30 LB
2849	DEVRIKOL 2XT	2.5 GAL
2866	DEVRIKOL 50DF-XT	4 LB
13134	DICAMBA DMA	2.5 GAL
2618	FORMULA 40 - MA RUP	2.5 GAL
5100	GARLON 4 ULTRA	2.5 GAL
2374	GOAL 2XL	2.5 GAL
2646	IMPACT 2.8SC	30 OZ
10759	INTENSITY ONE	2.5 GAL
13375	INTERLINE	2.5 GAL
13074	KARMEX DF	5 LB
4921	LINEX 4L	2.5 GAL
2484	LOROX DF	20 LB
496	LUMAX EZ - RUP	2.5 GAL
2668	MATRIX SG	20 OZ
4295	MEDAL II EC -MA RUP	2.5 GAL
446	POAST	2.5 GAL
2464	PREFAR 4E	2.5 GAL
9	PROFINE 75	10 OZ
2383	PROWL H20	2.5 GAL
15065	RANCOR 75DF - MA RUP	5 LB
2334	REGLONE	2.5 GAL
10429	ROUNDUP POWERMAX3	2.5 GAL
2351	SANDEA	10 OZ
4059	SCYTHE	2.5 GAL
4628	SIMAZINE 4L - MA RUP	2.5 GAL
2601	SINBAR 80WDG	5 LB
10354	SOTRION 480 SC (MESOTRIONE)	1 GAL
13017	SPARTAN 4F	GAL
1111	STINGER	2.5 GAL
1580	STRATEGY	2.5 GAL
12297	TRIFLURALIN 4EC	2.5 GAL
441	WEEDAR 64 BROADLEAF - MA RUP	2.5 GAL



# AGRICULTURAL CHEMICALS

## Insecticides

ITEM	DESCRIPTION	SIZES
15165	ABBA ULTRA - RUP	1 GAL
17	ACRONYX 4F	1 GAL
436	ACTARA - RUP	30 OZ
2491	AGRI-MEK SC	QT
535	ALTACOR	16 OZ
14197	ALTACOR EVO	45 OZ
15142	ARVIDA 30 SG	4 LB
2656	ASANA XL - RUP	1 GAL
14216	AVAUNT EVO	30 OZ
2946	BAYTHROID XL - RUP	1 GAL
2536	BESIEGE - RUP	2.5 GAL
2372	BRIGADE 2EC - RUP	1 GAL
4402	CARBARYL 4L	2.5 GAL
11897	CAVALRY II - RUP	1 GAL
2325	CONSERVE SC T&O INSECTICIDE	1 QT
714	CORAGEN EVO	1 QT
2350	DAMOIL	2.5 GAL
14176	DAMOIL	5 GAL
2317	DAMOIL	55 GAL
4141	DANITOL 2.4 EC - RUP	1 GAL
2547	DEADLINE BULLETS	50 LB
5154	DELEGATE WG	26 OZ
10586	ESSENTRIA IC PRO INSECTICIDE CONCENTRATE	1 GAL
14987	FANFARE EC - RUP	1 GAL
3159	FULFILL APHCIDE	27.5 OZ
3636	IMIDAN 70WSB	5 LB
5152	INTREPID 2F - MA RUP	1 GAL
2410	LANNATE LV - RUP	2.5 GAL
2448	LANNATE SP - RUP	8 OZ
2375	LANNATE SP - RUP	32 OZ
5147	MALATHION 5EC	1 GAL
12147	MALATHION 5EC	2.5 GAL
10751	MOVENTO	1 GAL
2680	MUSTANG MAX - RUP	1 GAL
2519	PERM-UP 3.2EC - RUP	1 GAL
13064	PLATINUM 75SG - MA RUP	8 OZ
3797	PLATINUM 75SG - MA RUP	32 OZ
3962	RADIANT SC	1 QT
2663	RADIANT SC	1 GAL

## Insecticides Cont.

ITEM	DESCRIPTION	SIZE
5160	SEVIN XLR PLUS	2.5 GAL
3123	VENOM - RUP	16 OZ
1579	WARRIOR II - RUP	1 GAL

## Miticides

ITEM	DESCRIPTION	SIZES
2617	ACRAMITE 50WS	1 LB
2969	APOLLO SC	1 QT
16015	KANEMITE 15SC	124 OZ
4117	NEALTA	137 OZ
15205	NEXTER SC	1 GAL
5054	PORTAL XLO	2.5 GAL
2619	SAVEY 50DF	12 OZ
3911	ZEAL MITICIDE WSP	12 OZ

## Plant Growth Regulators

ITEM	DESCRIPTION	SIZES
6	ACCEDE SG	20 OZ
2977	APOGEE	5 LB
2512	FRUITONE L	1 GAL
2927	FRUITONE N	20 OZ
2959	MAXCEL	1 GAL
2945	PROMALIN	1 QT
2602	RETAIN	0.73 LB



# UNLOCK YOUR SOIL'S FULL POTENTIAL

## Solu-Cal

### Powered by *INTENSIFY Microbial BioCatalyst*

- ✓ IMMEDIATELY available Calcium for improved plant growth
- ✓ Adjusts soil pH in just 6 to 8 weeks
- ✓ With INTENSIFY Biological for MAXIMUM nutrient use efficiency

## Ask Us About Solu-Cal Enhanced Calcium Products



- Powered by INTENSIFY Microbial BioCatalyst with 9 strains of beneficial bacteria & fungi.
- Multiple applications in one bag to save time, money, storage, and labor.
- Get six weeks of improved water use efficiency with Aqua-Ca Technology on select products.

### Enhanced Calcium Soil Amendments

Lawn & Landscape | Golf & Sports Turf | Wildlife Food Plots | Specialty Agriculture

**FS GROWMARK FS, LLC**

Fertilizer • Seed  
Crop Protection • Crop Nutrients  
Get more from each acre  
with GROWMARK products.



**InVISION**  
SEED CORN

**HiSOY**  
SOYBEAN

**InSPiRE**  
WHEAT

**FORAGE**  
CORN

# FERTILIZER

## Blended Granular Fertilizers

ITEM	DESCRIPTION	SIZE
2677	5-15-30 FERTILIZER	50 LB
2882	10-10-10-9S FERTILIZER W/ MICROS	50 LB
4953	10-20-10-6.5S ASM CROP STARTER	50 LB
2793	10-20-20-6.7S FERTILIZER W/ MICROS	50 LB
11752	15-15-15 FERTILIZER	50 LB
4952	13-13-13-12S FERTILIZER W/ MICROS	50 LB
4865	14-7-14-14S ASM FERTILIZER	50 LB
4802	18-11-17 50% XCU	50 LB
4867	18-8-18-6S CRANBERRY FERTILIZER	50 LB
3741	19-19-19 FERTILIZER	50 LB
4863	18-18-18 MICROS	50 LB
2596	24-12-18	50 LB
4799	28-7-14	50 LB
4803	30-0-20 FERTILIZER	50 LB

## Soil Amendments

ITEM	DESCRIPTION	SIZE
2852	PULVERIZED AG LIME HI-MAG	50 LB
5087	HYDRATED LIME HI-MAG	50 LB
13523	PELLETIZED LIME HI-CAL (OMRI)	50 LB
13522	PELLETIZED LIME HI MAG (OMRI)	50 LB
12412	PELLETIZED GYPSUM (OMRI)	50 LB
11979	PULVERIZED GYPSUM	50 LB

## Fertilizer Components

ITEM	DESCRIPTION	SIZE
14286	0-45-0 TRIPLE SUPER PHOSPHATE	50 LB
10430	0-0-22-11MG-22S KMAG / SUL-PO-MAG	50 LB
539	0-0-50 POTASSIUM SULFATE/SULFATE OF POTASH	50 LB
2578	0-0-60 POTASSIUM CHLORIDE/MURIATE OF POTASH	50 LB
2828	11-52-0 MAP GRANULAR	50 LB
480	21-0-0-24S AMM SULFATE GRANULAR	50 LB
4928	46-0-0 UREA GRANULAR	50 LB
10231	ALUMINUM SULFATE 17%AL 16%S GRANULAR	50 LB
10218	BORON 10% GRANULAR	50 LB
2908	CALCIUM NITRATE 15-0-0 AG GRADE	50 LB
3519	COPPER ZINC SULFATE 15% CU-10%ZN-6%S	50 LB
3851	IRON SULFATE 50% FE 5% S GRANULAR	50 LB
3516	MANGANESE SULFATE 28% 6% S GRANULAR	50 LB
3518	ZINC SULFATE 36% GRANULAR 5% S	50 LB



## Solu-Cal Products

ITEM	DESCRIPTION	SIZE
1551	SOLU-CAL L LIQUID	2.5 GAL
567	SOLU-CAL PLUS ENHANCED CALCIUM	50 LB
4367	SOLU-CAL HUMIC PLUS	50 LB
1861	SOLU-CAL S GRANULAR W/ INTENSIFY	50 LB
10494	SOLU-CAL PEAK IRON PLUS	50 LB
10818	AQUA-CAL WITH HUMIC PLUS	50 LB
12384	6-12-6 W/ AQUA-CAL	50 LB

**Pelletized lime is available in 2000 lb bulk bags.  
Custom Grades Available**





# MASTERBLEND®

PREMIUM FERTILIZERS

# Complete Solubility



***Say goodbye to clogged lines, filters and injection systems.***

Masterblend® is a premium-grade water-soluble fertilizer that completely dissolves in all types of water. Made with only the highest quality, technical-grade materials to deliver exceptional nutrition for optimal growth and healthier plants.

Contact Progressive for Available Formulations!



[masterblend.com](http://masterblend.com)

# FERTILIZER

## Soluble Fertilizer

ITEM	DESCRIPTION	SIZE
3789	21-0-0 AMM SULFATE SPRAYABLE	50 LB
3058	4-2-41-2 MG CROP FINISHER	25 LB
4382	5-10-27 HARVESTMORE UREAMATE	25 LB
4813	46-0-0 FEED GRADE UREA	50 LB
15034	0-52-34 MONOPOTASSIUM PHOSPHATE	55 LB
14175	BORON 21% (OMRI)	44 LB
5056	CALCIUM CHELATE SOLUBLE 9.5%	5 LB
14894	CALCIUM NITRATE 15.5-0-0-19%CA GREENHOUSE GRADE	50 LB
4783	COPPER SULFATE FINE 25%	50 LB
3065	IRON CHELATE DP 10%	5 LB
1852	IRON SULFATE 30% FERROUS	50 LB
3517	MAGNESIUM SULFATE (EPSOM SALT) (OMRI)	50 LB
3790	MANGANESE SULFATE 32% SOLUBLE (TECHMANGAN) (OMRI)	55 LB
15050	MOLYBDENUM SODIUM MOLYBDATE	5 LB
2583	POTASSIUM NITRATE GREENHOUSE	50 LB
4535	ZINC SULFATE 35% ZN 17% S (OMRI)	50LB
15893	MOST (MIX OF SOLUBLE TRACE NUTRIENTS)	25 LB



## MASTERBLEND®

PREMIUM FERTILIZERS

## Masterblend Soluble Fertilizers

ITEM	DESCRIPTION	SIZE
2621	20-10-20 ALL PURPOSE	25 LB
2622	20-20-20 ALL PURPOSE	25 LB
3050	10-30-20 ALL PURPOSE	25 LB
2630	17-6-6 ACID GREENING	25 LB
14976	17-5-17 CAL-MAG	25 LB
2625	15-0-15 DARK WEATHER	25 LB
11805	15-15-15 GERANIUM FORMULA	25 LB
2624	5-11-26 HYDROPONIC	25 LB
13231	22-5-16 PETUNIA/MUM FORMULA	25 LB
3049	9-45-15 PLANT STARTER	25 LB
2626	15-16-17 SOIL-LESS	25 LB
2627	4-18-38 TOMATO FORMULA	25 LB





**PROGRESSIVE GROWER**  
 carries a vast amount of organic offerings.

We are proud dealers for

**Fertrell, Kreher's, Nature's Safe**

*We are constantly adding to our inventory.  
 Please reach out to us if you don't see  
 something in our catalog.*

While we do our best to research all of our products for use by organic growers, it is the responsibility of the farmer to determine if they pass USDA organic requirements before purchasing and using them. Some products that have OMRI or Nat'l List status can lose that standing at any time without notice. We are not responsible for products purchased that can not be used in certified OG operations. Check with your certifying agency for current status of a product. Not all of the products that we sell are registered in every state. It is your responsibility to comply with the laws of your state. Please check with your state department of agriculture if you are unsure.

**PRICES IN THIS CATALOG ARE SUBJECT TO  
 CHANGE WITHOUT NOTICE.**

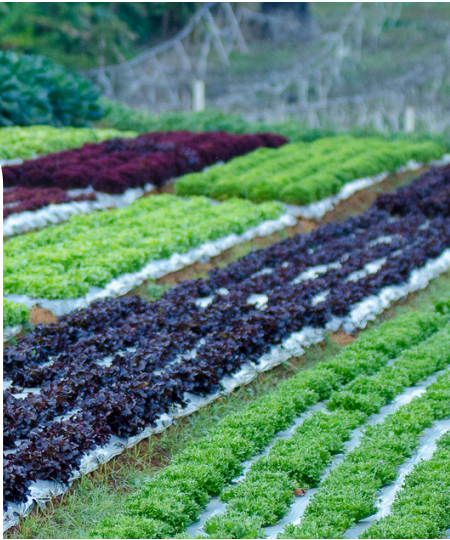



# ORGANIC PRODUCTS



## 8-2-2

Crafted from a mixture of composted poultry manure and feather meal, this product serves as a versatile option suitable for new turf, established lawns, and vegetable crops. With nitrogen content at 8%, phosphate at 2%, and soluble potash at 2%, it offers a balanced nutrient profile. Particularly beneficial for soils rich in phosphate, this blend provides a slow-release nitrogen source.

ITEM	DESCRIPTION	PRICE
3553	50 LB BAG	\$29.95
3568	2000 LB BULK BAG	\$1,095.00

## 5-4-3 with 9% calcium

Pelleted compost is most effectively utilized as an initial application within the planter or as a supplementary dressing for vegetables. An advantage of pelleted compost lies in its ability to flow smoothly through drop spreaders.

ITEM	DESCRIPTION	PRICE
13785	40 LB BAG	\$14.85
4641	2000 LB BULK BAG	\$550.00

## 5-4-3 Sunrise with 8% Calcium

Made from composted composted poultry manure with higher amounts of calcium. Pelleted compost is best used as a starter through the planter or as a side dress for vegetables. One of the benefits of the pelleted compost is that it will flow easily through drop spreaders. Made from composted chicken manure sourced from organic poultry.

ITEM	DESCRIPTION	PRICE
3569	50 LB Bag	\$18.50

## 4-3-10

Comprised of composted poultry manure and OMRI-listed sulfate of potash, this fertilizer serves as an excellent option for initiating corn crops. It is versatile, suitable for application on various plants including vegetables, trees, shrubs, and flowers. With a nutrient composition of 4% Nitrogen, 3% phosphate, and 10% soluble potash, it offers a balanced blend for plant development.

ITEM	DESCRIPTION	PRICE
3525	50 LB BAG	\$22.95
10230	2000 LB BULK BAG	\$785.00

## 7-2-6

Made of composted poultry manure, organically approved feather meal, OMRI listed blood meal, and OMRI listed sulfate of potash. The blood meal helps provide a quicker Nitrogen release that sustains over time, as well as a boost of Potassium.

ITEM	DESCRIPTION	PRICE
13411	50 LB BAG	\$31.95
13410	2000 LBS BULK BAG	\$1,125.00





# PRODUCTS FROM THE OCEAN, TO SET YOUR PLANTS IN MOTION



**ORGANIC FERTILIZERS**

**LIQUID FISH HYDROLYSATE,  
FISH & SEAWEED BLEND,  
CRAB & LOBSTER, AND MORE!**

**INCREASE YIELD & QUALITY  
HEALTHIER SOIL & CROPS  
GROW NUTRIENT-DENSE FOOD  
BULK & RETAIL AVAILABLE**

## NEPTUNE'S HARVEST ORGANIC FERTILIZERS

Family Owned and Operated Since 1965 • Gloucester, MA



- Rich in Organic Matter and Nutrients
- Helps Condition and Enrich Soil
- Available in Bulk, Totes and Bags

## Organic Compost & Fertilizer

For decades, our family has used the manure from our laying hens as a crop fertilizer on our farm.

Today, we are pleased to offer a variety of composted layer manure and dry, granular fertilizer blends for use in organic crop production



Scan to Learn More



- 5-4-3 OMRI Listed
- 8-2-2 Blend
- 4-3-10 Blend
- 7-2-6 Blend

# ORGANIC PRODUCTS



## Fish & Seaweed Fertilizer 2-3-1

Neptune's Harvest Organic Fish/Seaweed Blend Fertilizer offers a blend of hydrolyzed fish and seaweed for a complete fertilization program. Users have reported increased yields, improved shelf life, stronger plants, colorful flowers, and more abundant blooms. **OMRI Listed**

ITEM	DESCRIPTION	PRICE
13193	1 PT BOTTLE	\$8.95
3501	1 QT BOTTLE	\$15.99
4631	1 GALLON JUG	\$33.95
3871	5 GALLON BUCKET	\$129.95
4736	55 GALLON DRUM	\$595.95
13403	275 GALLON TOTE	\$2,759.85

## Fish Fertilizer 2-4-1

A unique cold process protects heat sensitive nutrients naturally found in fish, providing you with the best fertilizer available! We believe in making the highest quality fish hydrolysate, which is why our liquid fish uses a variety of dock-fresh North Atlantic fish. Unlike fish emulsions, Neptune's Harvest doesn't remove the proteins or oils during processing and has no unpleasant odor. **OMRI Listed**

ITEM	DESCRIPTION	PRICE
3420	1 PT BOTTLE	\$8.95
11995	1 QT BOTTLE	\$14.99
12221	1 GALLON JUG	\$29.85
3870	5 GALLON BUCKET	\$114.95
3916	55 GALLON DRUM	\$438.45
3872	275 GALLON TOTE	\$2,049.95

## Seaweed Plant Food 0-0-1

Neptune's Harvest Seaweed Plant Food is made from Ascophyllum Nodosum that grows along the cold North Atlantic Ocean Floor. We recommend use as an addition to a regular program of Neptune's Harvest Fish Fertilizer. **OMRI Listed**

ITEM	DESCRIPTION	PRICE
4837	1 GALLON JUG	\$29.95
11724	5 GALLON BUCKET	\$128.95
4403	55 GALLON DRUM	\$557.35
4404	275 GALLON TOTE	\$2,429.75

## Rose & Flowering Formula 2-6-4

Rose & Flowering fertilizer enhances flowering plant vigor, bud volume, and density for vibrant flowers. Made with fresh fish, molasses, yucca extract, seaweed, and humic acids, it promotes plant health, lush foliage, and optimal flowering.

ITEM	DESCRIPTION	PRICE
14193	1 GALLON JUG	\$38.95
14239	5 GALLON BUCKET	\$149.75

## Tomato & Veg Formula 2-4-2

This fertilizer, made from fish, seaweed, molasses, yucca extract, and humic acids, is tailored for plants during growth stages. Users have observed enhanced plant growth, higher yields, strong root systems, and better disease resistance with this formula.

ITEM	DESCRIPTION	PRICE
13663	1 PT BOTTLE	\$9.95
13194	1 QT BOTTLE	\$14.99
13195	1 GALLON JUG	\$44.95
11969	5 GALLON BUCKET	\$144.95
13579	55 GALLON DRUM	\$1,195.85

## Kelp Meal 1-0-2

Its is derived from Rock Weed (Ascophyllum Nodosum) from the New England coast, rich in nutrients for plants. It enhances soil quality, moisture retention, and promotes healthy, green lawns and plants when used before planting or as a top dressing. **OMRI Listed**

ITEM	DESCRIPTION	SIZE	PRICE
14962	KELP MEAL	12 LB	\$42.29
3570	KELP MEAL	50 LB	\$84.95





**Fertrell**<sup>®</sup>

SINCE 1946

Better Naturally!

**NATURAL AND ORGANIC FERTILIZERS, FEED SUPPLEMENTS, LIVESTOCK NUTRITION & AGRONOMY CONSULTING**

**Products are available through Progressive Grower**

81 Charlotte Furnace Road, West Wareham, MA 02576

(844) 357-6617 | [www.progressivegrower.com](http://www.progressivegrower.com)



# ORGANIC PRODUCTS



ITEM	DESCRIPTION	SIZE	PRICE
12812	SUPER K, 3-4-7	50 LB	\$37.95
12842	SUPER K, 3-4-7 WITH BORON	50 LB	\$35.50
10345	SUPER K, 3-4-7 WITH BORON & ZINC	50 LB	\$43.65
11744	BLUE N 5-1-1 FERTILIZER	50 LB	\$36.95
14527	GOLD SPECIAL STARTER 2-4-2	50 LB	\$32.95
4690	HOLLY CARE 4-6-4	50 LB	\$44.50
10330	BERRY MIX 4-2-4	50 LB	\$36.75
3864	SUPER N 4-2-4 FERTILIZER	50 LB	\$33.75
10344	SUPER N 4-2-4 Z, B	50 LB	\$35.00



ITEM	DESCRIPTION	SIZE	PRICE
4464	10-2-8 GRANULAR	50 LB	\$39.85
12072	10-2-8 GRANULAR	2000 LB	\$1585.00
12691	13-0-0 GRANULAR	50 LB	\$38.95
11950	13-0-0-4S GRANULAR	2000 LB	CALL
4465	9-0-9 GRANULAR	50 LB	\$39.95
4466	5-6-6 FINE	50 LB	\$37.95
10219	7-12-0 GRANULAR	2000 LB	\$1265.00
4285	8-3-5 SUPER FINE	50 LB	\$41.95
4284	8-5-5 GRANULAR	50 LB	\$38.95

## Liquid

ITEM	DESCRIPTION	SIZE	PRICE
4565	NATURE'S SOURCE 3-1-1 (OMRI)	4.7 GAL	\$73.95
15386	NATURE'S SOURCE 3-1-1 (OMRI)	55 GAL	\$687.30
11948	AGRIDYNAMIC CROP MANNA	2.5 GAL	\$67.95
11946	AGRIDYNAMIC FOLIATE-K	2.5 GAL	\$57.95
11666	AGRIDYNAMIC PLANT-SURE	2.5 GAL	\$89.75
15459	HUMIK HUMIC FULVIC (OMRI)	2.5 GAL	\$45.00
12843	FERTRELL 2-3-1 #3	1 GAL	\$28.95
15968	FERTRELL 2-3-1 #3	2.5 GAL	\$66.80
3793	FERTRELL 3-4-3	1 GAL	\$29.75
15444	FERTRELL 3-4-3	2.5 GAL	\$82.50

## Soluble

ITEM	DESCRIPTION	SIZE	PRICE
4332	0-0-50-17S POTASSIUM SULFATE SOLUBLE (OMRI)	50 LB	\$53.95
14155	7-7-7 NATURE SAFE	50 LB	\$72.95

## Other

ITEM	DESCRIPTION	SIZE	PRICE
4573	ALFALFA MEAL 3-1-2	50 LB	\$31.95
10226	CRAB AND LOBSTER SHELL 2.5-3-0.5, FLOUR (WHEN AVAILABLE)	44 LB	\$68.95



# ORGANIC PRODUCTS

## Nitrogen

ITEM	DESCRIPTION	SIZE	PRICE
3164	BLOOD MEAL 12-0-0	50 LB	\$75.95
5117	FEATHER MEAL 13-0-0	50 LB	\$54.00
3011	NITRATE OF SODA 15-0-2 (OMRI)	50 LB	\$51.95
3008	PEANUT MEAL 8-1-1	50 LB	\$33.50
15476	COTTONSEED MEAL	50 LB	\$26.50

## Phosphorus

ITEM	DESCRIPTION	SIZE	PRICE
4331	CALPHOS 0-3-0 20% CA	50 LB	\$21.95
12555	PHOSTRELL 0-6-0	50 LB	\$34.50

## Azomite

ITEM	DESCRIPTION	SIZE	PRICE
15445	AZOMITE GRANULAR	10 LB	\$17.00
3446	AZOMITE GRANULAR	44 LB	\$36.95
12570	AZOMITE MICRONIZED 200 MESH POWDER	44 LB	\$42.50

## Adjuvants

ITEM	DESCRIPTION	SIZE	PRICE
10223	BIOLINK - SURFACTANT & PENETRANT	2.5 GAL	\$87.95
12186	BIOLINK ACIDIFIER	2.5 GAL	\$53.95
12184	BIOLINK ANTI-FOAM (OMRI)	1 GAL	\$89.95
3912	NUFILM P SPREADER/STICKER (OMRI)	1 GAL	\$66.85
3988	KINETIC SPREADER (OMRI)	1 GAL	\$110.00

## Potassium

ITEM	DESCRIPTION	SIZE	PRICE
4470	0-0-22-11MG-22S TRIO SULPOMAG GRANULAR (OMRI)	50 LB	\$29.75
4920	SULFATE OF POTASH 0-0-50 GRANULAR (OMRI)	50 LB	\$39.95
13513	SULFATE OF POTASH 0-0-50-17S GRANULAR (OMRI)	2000 LB BULK	CALL
15475	SUNFLOWER HULL ASH	50 LB	\$37.75
12026	GREEN POTASH	50 LB	\$29.95

## Micro Nutrients

ITEM	DESCRIPTION	SIZE	PRICE
3791	ARAGONITE FLOUR GRADE	50 LB	\$18.95
10218	BORON 10% 0-0-0-10 (OMRI)	50 LB	\$28.95
3790	MANGANESE SULFATE 0-0-0-18-32 WATER SOLUBLE (OMRI)	55 LB	\$71.50
4309	SULFUR ROCKET 90% (OMRI)	50 LB	\$31.00
14190	WORM CASTINGS	25 LB	\$32.95
5118	ZEOLITE	50 LB	\$34.95
12238	WOLLASTONITE	50 LB	\$30.35
3170	TIGER-ZINC SULFATE	50 LB	\$74.95
10511	TIGER-MANGANESE SULFATE	50 LB	\$69.95
14884	COPPER 12% TIGER	50 LB	\$126.75
14885	IRON 22% TIGER	50 LB	\$65.25

**CUSTOM MIXES ARE AVAILABLE.**



# ORGANIC PRODUCTS

## FUNGICIDES

ITEM	DESCRIPTION	SIZE
2790	ACTINOVATE AG	18 OZ
13814	AGRIPHAGE - FIREBLIGHT	2.5 GAL
2935	BADGE X2 (OMRI)	10 LB
12092	BOTRYSTOP BIOFUNGICIDE	12 LB
11925	CEASE	1 GAL
11641	CONTANS WG BIOFUNGICIDE (OMRI)	25 LB
2643	CUEVA (OMRI)	2.5 GAL
3181	DOUBLE NICKEL 55 (OMRI)	5 LB
4542	DOUBLE NICKEL LC (OMRI)	2.5 GAL
821	ECOSWING (OMRI)	1 QT
15121	ECOSWING (OMRI)	2.5 GAL
14314	HOWLER 2 (OMRI)	25 LB
4235	KALIGREEN (OMRI)	5 LB
10838	MASTERCOP (OMRI)	2.5 GAL
12380	LIFEGARD WG BIOFUNGICIDE (OMRI)	1 LB
15080	LIME SULFUR, BRANDT (OMRI)	2.5 GAL
498	NORDOX 75WG (OMRI)	20 LB
4080	NU-COP HB (OMRI)	10 LB
4112	OSO SC (OMRI)	1 QT
497	OXIDATE 2.0 (OMRI)	2.5 GAL
12974	OXIDATE 2.0 (OMRI)	5 GAL
14814	OXIDATE 2.0 (OMRI)	30 GAL
13595	PREVISTO (OMRI)	2.5 GAL
2636	REGALIA (OMRI)	2.5 GAL
15880	REGALIA CG (OMRI)	1 QT
15881	REGALIA CG (OMRI)	1 GAL
11655	ROOTSHIELD PLUS WP	1 LB
2917	ROOTSHIELD PLUS WP	3 LB
14358	SANIDATE 5.0	2.5 GAL
3088	SANIDATE 5.0	5 GAL
13169	SANIDATE 5.0	55 GAL
15867	SANIDATE 12.0	5 GAL
4489	SIL-MATRIX (OMRI)	2.5 GAL
2130	SERENADE ASO (OMRI)	2.5 GAL
15122	STARGUS FUNGICIDE (OMRI)	2.5 GAL
14995	STOROX 2.0 FUNGICIDE	30 GAL
2632	STYLET OIL JMS ORGANIC	2.5 GAL
4762	STYLET OIL JMS ORGANIC	15 GAL

## INSECTICIDES

ITEM	DESCRIPTION	SIZE
11760	AGREE WG INSECTICIDE (OMRI)	5 LB
12187	AZAGUARD (OMRI)	32 OZ
13254	AZAGUARD (OMRI)	1 GAL
4058	AZERA (OMRI)	1 GAL
4632	BIOCERES WP (OMRI)	16 OZ
3907	BT NOW (OMRI)	1 GAL
15633	BT NOW (OMRI)	2.5 GAL
10966	CAPTIVA PRIME INSECTICIDE	1 QT
4838	DIATOMACEOUS EARTH	50 LB
2487	DIPEL DF (OMRI)	1 LB
4982	DIPEL DF (OMRI)	5 LB
2447	ENTRUST SC (OMRI)	1 QT
13873	GRANDEVO WDG (OMRI)	6 LB
10678	MAJESTENE NEMATICIDE (OMRI)	2.5 GAL
12192	MELOCON WG BIO NEMATICIDE	20 LB
4190	M-PEDE MITCIDE (OMRI)	2.5 GAL
4505	MYCOTROL ESO MYCOINSECTICIDE	1 QT
13474	MYCOTROL ESO MYCOINSECTICIDE	1 GAL
10714	SLUGGO 1% IRON PHOSPHATE (OMRI)	50 LB
5076	PFR-97 20%WDG MICROBIAL INSECTICIDE (OMRI)	5 LB
4116	PYGANIC 1.4EC (OMRI)	1 QT
2446	PYGANIC 1.4 EC (OMRI)	1 GAL
11725	PYGANIC 5.0 EC (OMRI)	1 QT
2387	PYGANIC 5.0 EC (OMRI)	1 GAL
11941	SEDUCE INSECT BAIT (OMRI)	50 LB
2450	SURROUND WP (OMRI)	25 LB
287	VENERATE CG	1 QT
3960	VENERATE XC (OMRI)	2.5 GAL

## HERBICIDES

ITEM	DESCRIPTION	PRICE
3429	AXXE (OMRI)	5 GAL
10222	SUPPRESS EC (OMRI)	2.5 GAL
13241	VINEGAR WHITE	1 GAL
13212	VINEGAR WHITE	55 GAL

**We Sell IPM Traps and Lures - Call for More Info  
Made to Order  
Allow 3-Week Lead Time**





# King's AgriSeeds<sup>Inc.</sup>

FEEDING YOUR FARM'S FUTURE.

- COVER CROPS
- WINTER ANNUALS
- SUMMER ANNUALS
- PERENNIAL MIXTURES
- AWARD WINNING KINGFISHER  
CORN HYBRIDS
- POLLINATOR MIXTURES
- AND MORE

**Call your local dealer today!**

**Visit [kingsagriseeds.com](http://kingsagriseeds.com) for more information**

**717-687-6224**

# Cover Crops

## COVER CROP SEEDS

ITEM	DESCRIPTION	SIZE
15717	40-10 FORAGE PEA UT	50 LB
4348	ANNUAL RYEGRASS SEED LOWBOY UT	50 LB
5098	BRACO WHITE MUSTARD	50 LB
13618	BUCKWHEAT UT	50 LB
2697	DAIKON RADISH UT	50 LB
11848	GREEN-N-LOW CLOVER/ANNUAL RYEGRASS	50 LB
3115	HAIRY VETCH SEED VNS UT	50 LB
2693	IRON & CLAY COWPEA UT	50 LB
14367	KEYSTONE WINTER PEA UT (AUSTRIAN TYPE)	50 LB
12445	OATSEED VNS UT	48 LB
4345	OAT/40-10 PEA SEED MIX	50 LB
4778	PEREDOVIK SUNFLOWER UT	40 LB
4421	SUNN HEMP UT	50 LB
15709	TRITICALE GAINER 154 VT	50 LB
4177	WHEAT SEED MALABAR UT	50 LB
14366	WINTER RYE UT	56 LB
12129	LILA PHACELIA	5 LB

## FORAGE SEED

ITEM	DESCRIPTION	SIZE
15708	ALFALFA SEED 435HP	50 LB
2690	ALSIKE CLOVER UT	50 LB
2688	CLIMAX TIMOTHY	50 LB
4161	COMPANION GRASS SEED MIX UT	25 LB
13888	EQUIFLEX FORAGE SEED MIX	33 LB
13275	HILLSIDE SEED MIX	33 LB
15037	KING'S HAYPRO SEED MIX	33 LB
13605	KING'S HORSE SUPREME SEED MIX	33 LB
4193	VERSA SEED MIX	33LB
14045	MEDIUM RED CLOVER CO	50 LB
10615	LADINO CLOVER SEED VNS	50 LB

## ORGANIC COVER CROP SEEDS

ITEM	DESCRIPTION	SIZE
5074	4010 FORAGE PEA OG	50 LB
10317	BUCKWHEAT OG	50 LB
2695	CLOVER CRIMSON OC	50 LB
4721	CLOVER DUTCH WHITE	25 LB
14260	CLOVER RIVENDEL WHITE OG	25 LB
13372	YELLOW BLOSSOM SWEET CLOVER OC	50 LB
13295	HAIRY VETCH PATAGONIA OC	50 LB
12202	KING'S 3 WAY CLOVER SEED MIX	50 LB
4583	OAT/40-10 PEA SEED MIX OG	50 LB
12197	SUMMERMAX CC6 SEED MIX	50 LB
15239	WINTER RYE OG	50 LB

## ORGANIC FORAGE SEED

ITEM	DESCRIPTION	SIZE
15446	CLOVER RED HARMONIE OG	50 LB
4189	CLOVER MEDIUM RED OC	50 LB
10615	CLOVER LADINO SEED OC	50 LB
12029	KING'S ORGANIC PARTNER SEED MIX OG	33 LB
14013	ORCHARDGRASS ECHELON OG	25 LB

## SEED INOCULANT

ITEM	DESCRIPTION	TREATS
11692	EXCEED ALFALFA/CLOVER	100 LB
11691	EXCEED COWPEA/ SUNN HEMP/MUNG BEAN	100 LB
11672	EXCEED PEA/VETCH/LENTIL/FABA BEAN	100 LB

**OG - Organic**

**OC - Organic Coated**

**UT - Untreated**

**ALTERNATIVE SEED VARIETIES AND SIZES ARE AVAILABLE. KINDLY CONTACT US FOR FURTHER DETAILS.**



## BCS TWO-WHEEL TRACTORS

### Model 749

**ENGINE:** Honda GX390 Recoil (Electric Start Optional)

**WORKING SPEEDS:** 3 forward, 3 reverse; 0.9, 2.0 and 3.0 MPH

**STD. WHEELS:** 5" x 12" (22" tires)

**WHEEL WIDTH:** 22" (variable)

**WEIGHT:** 344 lbs (with 26" Tiller)

354 lbs (with 30" Tiller)

ITEM	ENGINE	PRICE
12031	RECOIL START	\$6,395.85
13319	ELECTRIC START	\$6,899.00



### Model 732

**ENGINE:** Kohler CH395 (Electric Start Optional)

**WORKING SPEEDS:** 2 forward, 2 reverse; 0.7 and 1.7 MPH

**STD. WHEELS:** 4" x 10" (18" tires)

**WHEEL WIDTH:** 21" (variable)

**WEIGHT:** 295 lbs (with 26" Tiller)

*An optional upgrade to 5" x 10" x 19" wheels/tires is required to operate the Rotary Plow and Brush Mower attachments.*

ITEM	ENGINE	PRICE
14215	RECOIL START	\$4,149.00
12564	ELECTRIC START	\$4,499.00



### Model 739

**ENGINE:** Honda GX340 Recoil (Electric Start Optional)

**WORKING SPEEDS:** 3 forward, 3 reverse; 0.8, 1.8 and 2.7 MPH

**STD. WHEELS:** 5" x 10" (19" tires)

**WHEEL WIDTH:** 22" (variable)

**WEIGHT:** 313 lbs (with 26" Tiller)

323 lbs (with 30" Tiller)

ITEM	ENGINE	PRICE
11031	RECOIL START	\$5,269
11645	ELECTRIC START	\$5,669



### Model 853

**ENGINE:** Honda GX390 Recoil (Electric Start Optional)

**WORKING SPEEDS:** 3 forward, 3 reverse; 0.9, 2.0 and 3.0 MPH

**STD. WHEELS:** 5" x 12" (22" tires)

**WHEEL WIDTH:** 22" (variable)

**WEIGHT:** 340 lbs (with 26" Tiller)

350 lbs (with 30" Tiller)

ITEM	ENGINE	PRICE
12083	RECOIL START	\$5,999.00
11032	ELECTRIC START	\$6,499.00



# EQUIPMENT

## BCS TRACTOR ATTACHMENTS

### REAR TINE TILLER

Prepare seedbeds, power compost, and cultivate with precision and ease

ITEM	DESCRIPTION	PRICE
13191	18"	\$899
11033	20"	\$999
11034	26"	\$1,149
12033	30"	\$1,209

#### Popular Accessories:

- Precision Depth Roller for 26" and 30" Tillers
- Transport Wheels
- Hiller / Furrower



### POWER HARROW

Makes minimal impact on soil structure by stirring the soil while creating perfectly level seedbeds.

ITEM	DESCRIPTION	PRICE
14006	21"	\$2,749
14261	30"	\$2,849
11036	32"	\$2,949

#### Recommended Accessories:

- Bumper Weight Kit

#### Required Accessories:

- Quick Hitch Bushing



### ROTARY PLOW

Effortlessly build raised beds, dig drainage ditches, and more.

**Swivel Rotary Plow:** Similar to the standard Rotary Plow, but with a lever that allows the operator to discharge soil to the right OR left.

ITEM	DESCRIPTION	PRICE
11035	SINGLE	\$1,999
13320	SWIVEL	\$3,099

#### Required Accessories:

- Wheel Extensions



### FLAIL MOWER

Pulverize everything from cover crops to heavy brush into mulch with swinging hammer blades.

ITEM	DESCRIPTION	PRICE
14918	24"	\$3,099
13160	30"	\$3,249
12371	35"	\$3,499



### UTILITY TRAILER

Haul loads up to 1100 pounds behind your BCS tractor.

ITEM	PRICE
13828	\$1,929



### BRUSH MOWER

Two swinging blades turn overgrown areas into second-tier lawn

ITEM	DESCRIPTION	PRICE
9466	21"	\$1,699
12321	26"	\$1,799
13906	32"	\$1,999

- Model 718 requires 5" x 10" wheels to operate the 21" Brush Mower
- Recommend 5" x 12" Wheels for optimal use with the 32" Brush Mower.

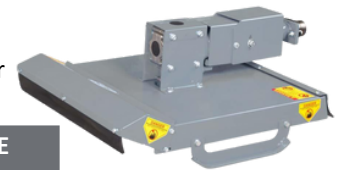

### SICKLE MOWER

Quickly mow tall grass, brush, even saplings with no flying debris.

ITEM	DESCRIPTION	PRICE
12060	30"	\$719
12369	40"	\$819
12374	45"	\$889
12372	53"	\$989

ITEM	DESCRIPTION	PRICE
12062	Oil Bath Transmission for Sickle Mower	\$1,099



**Many More Attachments Available, Will send BCS Catalog on Request**



# EQUIPMENT



## WATER WHEEL TRANSPLANTERS

Water Wheel Transplanters pass over a completed plastic mulch bed (performs equally well in raised or flatbed applications) planting wheel punches and waters the hole completely, and allows the operators, riding in a comfortable position, to place a plug, potted or bare root plant directly into the watered hole. Plant mortality is kept extremely minimal.

**COMPACT DESIGN allows closer row centers, shorter turns & increases water & tray carrying capacities of a smaller tractor.**

Floating water wheel bracket, plants up to 3 rows (1-2 standard) per bed, Optional 3 wheel plumbing for 3 rows. Standard racks allow a total carrying capacity of 19 standard 1020 trays. Twenty-five plus with optional second top rack. Fully adjustable, comfortable high back cushioned seats with footrests for greater operator efficiency. The tank has a shut-off valve that can be reached by the planter personnel. Water flow into planter wheels can be adjusted independently.



**Model P1500**

Pull-type with large transport wheels. It converts easily to a 3-point hookup by pulling 3 pins and dropping the hitch. Has an adjustable turnbuckle on the hitch for easy leveling. Used tires with new rims. Steel wheels are optional. 150-gallon tank.



**Model P150 3-point Hookup:**

3-Point allows for a tighter turn radius at the end of the row. Cat 1 & 2 lift pins. Requires tractor with a lift capacity of almost 3000 lbs. 40-80 hp, 4WD, or loader help. 150-gallon tank.

ITEM	DESCRIPTION	PRICE
12040	MODEL P1500 COMBINATION	\$3,486.75

ITEM	DESCRIPTION	PRICE
11934	MODEL P150 3-POINT HOOKUP	\$2,975.00

**Order planting wheels separate, not included with the unit price.**

**Select from Table Below**

**Stock Planting Wheels, C Spike** - Choose spacing: 12, 15, 18, 24, 30, 36, 42, 48"

**Custom Planting Wheels** - Choose spacing & spike spacing

ITEM	DESCRIPTION
15944	PWS24 12=8", 6=16", 4=22", 3=28", 2=40", 1=77"
	PWS26 18=6", 9=12", 6=17", 3=31", 2=45", 1=86"
	PWS30 24=5", 12=10", 8=14", 6=19", 4=27", 3=35", 2=51", 1=98"

*Number of spikes = approx. spacing: i.e. on PWS26 you need 18 spikes for 6" spacing.*



Item # 12044

**P1520 Optional Second Top Rack**

Bolts on regular top rack, increases carrying capacity to 25 trays. **\$210.00**

**Hyd. Lift No-Till Unit For P1500**



**Hand Drawn Planter**

**Wheel Bracket**

Use with any planting wheels. For row marking or when it's too wet to go in field with a tractor. Will punch up to 3 rows (with 3 wheels), space and stagger as needed.



**Both models feature:**  
Quick and easy wrench free seat and unit height adjustment. Open back makes planting wheel changes easy, no bar to lift.

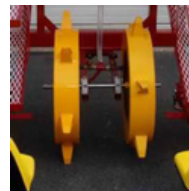

**Planter Wheel Spike Sizes**

	# A	# B	# C	# D	# E
Width at top →	2"	1 1/2"	1 1/4"	1 1/8"	1"
Length →	6"	5 1/2"	4 1/2"	4"	3 1/2"
Base →	4"	3 3/4"	2 5/8"	2 1/4"	2"
Snap-On Spike →	3" Pots	2 1/2" Pots	*Standard* 50 to 72 Count tray	72 to 96 Count tray	96 to 128 Count tray

**Additional Freight will Apply**



# EQUIPMENT

## MODEL 1670 WATER WHEEL TRANSPLANTER



Optional Top Tray & Side Ladder



Clear View To Plastic Row



Optional Trailer/3-Point Combination

### Standard Features

- Approximate Tractor Size: 50 - 70 HP FWD
- Will Plant 60" Row Centers (Minimum)
- Field Ready with One Planting Wheel
- Plants Bare Roots, Pots & Plugs
- Capability of 8" - 36" Row Spacing & One to Four Planting Wheels (Standard)
- Two 80 Gallon Tanks
- Up to 25 Tray Carrying Capacity
- Quick Change Planting Wheel Setup
- Easy Adjustment for Comfort on Seat & Foot Rest
- Large Tires with Highway Bearings
- Side Valve for Washing Hands
- Galvanized Expanded Metal Trays

### Options

- Side Ladder
- Top Tray
- Larger Rack To Fit Styrofoam Trays
- 3rd & 4th Seat with Trays
- Trailer / 3-Point Combination
- Quick Fill (2" Quick Coupler Connection)

ITEM	DESCRIPTION	PRICE
13649	*3-POINT PLANTER	\$3,150.00
11839	*3-POINT & TRAILER COMBINATION	\$3,600.00

\*One Standard Wheel of your choice Included\*

### Optional Attachments

ITEM	DESCRIPTION	PRICE
12595	SIDE LADDER	\$95.00
4706	TOP RACK BEHIND TANKS	\$140.00
12924	3RD OR 4TH SEAT WITH DOUBLE TRAY SHELF	\$360.00
11840	3RD & 4TH WHEEL PLUMBING	\$75.00
16095	TRAILER HITCH KIT UPGRADE FOR 3-POINT PLANTER	\$475.00

**Additional Freight will Apply**

Prices are subject to change without notice. Kindly contact us at (508) 273-7358 to verify pricing.



# EQUIPMENT



## MODEL 1270 WATER WHEEL TRANSPLANTER



Optional Trailer Hitch



Clear View To Plastic Row

### Standard Features

- Compact Water Wheel Transplanter w/ Category I and II 3-Point Hitch
- Recommended Tractor Size: 40 – 60 HP
- Field Ready w/ One Planting Wheel
- Plants Bare Roots, Pots, & Plugs
- Capability Of 8" – 16" Row Spacing & One Or Two Planting Wheels (Standard)
- Two 50 Gallon Water Tanks
- 10 Tray Capacity; 15 w/ Top Tray
- Will plant 62" Row Spacing (Minimum)
- Quick Change Planting Wheel Setup
- New Design Seat Adjustment; Easy On the Go Adjustment!
- Galvanized Expanded Metal Trays

### Options

- Extra Top Tray
- Trailer/3-Point Combination

ITEM	DESCRIPTION	PRICE
4700	*3-POINT PLANTER	\$2,800.00
8145	*3-POINT & TRAILER COMBINATION	\$3,000.00

\*One Standard Wheel of your choice Included

### Optional Attachments

ITEM	DESCRIPTION	PRICE
9233	TOP RACK BETWEEN TANKS	\$140.00
16096	TRAILER HITCH KIT UPGRADE FOR 3-POINT PLANTER	\$250.00

**Additional Freight will Apply**



# EQUIPMENT



## MODEL 2670 RAISED BED MULCH LAYER



Automatic Ro-Trak



Center Bed Fillers

### Standard Features

- 64" Row Centers w/ 4' Plastic
- Category II, 3-Point hitch
- Adjustable Plastic Width from 3' - 5'
- Adjustable Bed Height from 5' - 9'
- Adjustable Brake tension on plastic roll carriers
- Bed press has adjustable side press plates
- Operator Seat
- Adjustable row markers
- Replaceable, reversible plow share blades
- UHMW (Replaceable) plastic lined bed press
- Spring loaded shovels on side helps loosen soil for cover disk

### Options

- Center of Bed Fillers with Shear Bolt
- Drip irrigation Attachment
- Double Drip Irrigation attachment
- Crowned Raised Bed
- Stainless Steel Dry Fertilizer Attachment; Ground Drive w/ Side Seat

ITEM	DESCRIPTION	PRICE
12926	WITH AUTO RO-TRAK	\$6,550.00
15740	WITH MANUAL RO-TRAK	\$5,900.00

### Optional Attachments

ITEM	DESCRIPTION	PRICE
14017	CENTER OF BED FILLERS WITH SHEAR BOLT	\$195.00
14016	DRIP IRRIGATION ATTACHMENT	\$320.00
4699	DOUBLE DRIP IRRIGATION ATTACHMENT	\$485.00
12927	CROWNED RAISED BED	\$125.00
10348	STAINLESS STEEL DRY FERTILIZER ATTACHMENT; GROUND DRIVE W/ SIDE SEAT	\$2,000.00

**Additional Freight will Apply**

Prices are subject to change without notice. Kindly contact us at (508) 273-7358 to verify pricing.



# EQUIPMENT



## MODEL 2570 RAISED BED MULCH LAYER



Automatic Ro-Trak



Center Bed Fillers



### Standard Features

- 60" Row Centers w/ 4' Plastic
- Category II, 3-Point hitch
- Adjustable Plastic Width from 3' or 4'
- Adjustable Bed Height from 3" - 7"
- Adjustable Brake tension on plastic roll carriers
- Adjustable side press plates on bed press
- Operator Seat
- Adjustable row markers
- Replaceable, reversible plow share blades
- UHMW (Replaceable) plastic lined bed press
- Spring loaded shovels on side helps loosen soil for cover disk

### Options

- Drip irrigation Attachment
- Double Drip Irrigation attachment
- Crowned bed press for level fields
- Center fillers
- 400lb Ground Driven Dry Fertilizer Hopper
- Fumigation tank mounts with gas knives

ITEM	DESCRIPTION	PRICE
4697	WITH AUTO RO-TRAK	\$6,000.00
15741	WITH MANUAL RO-TRAK	\$5,350.00

### Optional Attachments

ITEM	DESCRIPTION	PRICE
15742	CENTER OF BED FILLERS WITH SHEAR BOLT	\$195.00
14016	DRIP IRRIGATION ATTACHMENT	\$320.00
4699	DOUBLE DRIP IRRIGATION ATTACHMENT	\$485.00
9658	CROWNED RAISED BED	\$125.00
9501	STAINLESS STEEL DRY FERTILIZER ATTACHMENT; GROUND DRIVE W/ SIDE SEAT	\$2,000.00

**Additional Freight will Apply**



# EQUIPMENT



## PLASTIC MULCH LIFTER



Accumulator and Cylinders on Model 500



**Plastic Mulch Lifters:** Designed to lift plastic better. Heavy Duty category 2, 3-point Hookup. Tractor with 50+ Hp required. Fully Adjustable, Lifts 3 to 5 ft wide plastic. Depth Control Wheels and Heavy Duty STRAIGHT Spring Loaded Trash/Vine Cutting Disks.

ITEM	DESCRIPTION	PRICE
13799	Model 500 Shear Bolt Protected	\$2,350.00
15732	Model 550 Auto Hydraulic Reset	\$3,360.00
13800	Optional Center Vine Cutting Disk	\$215.00

## PLASTIC MULCH WRAPPERS



MODEL 200



MODEL 250



MODEL 251

**Plastic Mulch Wrapper:** To remove plastic mulch and drip tape from the field. The hyd control, controls reel speed & also has a relief valve for safety. 24" wide reel holds 1200 ft plus of plastic & drip tape.

Model 250 and 200 have a removable end plate, simply flip two levers and pull off the end plate, The center is cone shaped making the plastic easy to remove.

Model 251 features a collapsible reel and no end plate for quick roll removal. Galvanized spool can not be used on 251. All units have category 1, 3-Point Hookup.

ITEM	DESCRIPTION	PRICE
14014	Model 200 3-pt Wrapper Hydraulic Drive	\$1,260.00
11955	Model 250 3-pt Hyd Wrapper w/Platform	\$1,555.00
11942	Model 251 3-pt Hyd Wrapper w/Platform & Collapsible Reel	\$1,555.00
13223	Reusable Spool for retrieval & storage of header lines, etc.	\$59.75

**Additional Freight will Apply**

Prices are subject to change without notice. Kindly contact us at (508) 273-7358 to verify pricing.



# EQUIPMENT



## FLATBED MULCH LAYER



**13748 - Model SL43 with - 13749 Optional Drip Attachment**



**15847 - Model SL5450 Combination Sweet Corn Model**

### TOP OF THE LINE SUPER DELUXE MULCH LAYERS FEATURE:

Heavy-duty spring-loaded drag gives a smooth, pressed seed bed and eliminates potholes. Furrow openers on the bottom of the drag give a consistent depth furrow and can't be pushed out of line by rocks.

High-speed dirt shields. Drag is easy to remove for laying clear plastic over the top of planted sweet corn or raised beds.

The adjustable spring tension on a plastic roll, 3" roller, and 16" rubber tire press wheels keep plastic under constant pressure resulting in uniform and tightly laid mulch.

The cover disks are independently spring-loaded and are fully adjustable. Extra roll carrier enables the machine to carry 2-4000' roll of plastic mulch

### COMBINATION MODEL

Pull type with large transport wheels converts easily to 3 Pt Hookup by pulling 3 pins and removing the hitch. Spring-assisted lever makes it easy to raise and lower the machine by hand when using it as a pull type. With used rubber tires and new rims. Steel transport wheels are optional for additional \$65.00

ITEM	MODEL	DESCRIPTION	PRICE
13748	Model SL43 3 Pt Hookup	Adjustable, Lays 4 or 3 ft plastic	\$1,610.00
3747	Model SL54 3 Pt Hookup	Adjustable, Lays 5 or 4 ft plastic	\$1,735.00
15846	Model SL4300 Combination Model	Adjustable, Lays 4 or 3 ft plastic	\$2,295.00
15847	Model SL5450 Combination Sweet Corn Model	Adjustable lays 4 & 5 ft. plasticover sweet corn ridges. Furrow Opening Disks included.	\$2,260.00

### ADDITIONAL ACCESSORIES

ITEM	DESCRIPTION	PRICE	
13749	DRIP IRRIGATION ATTACHMENT	Fully adjustable drip feed-in tube. Roll carrier shaft is mounted on ball bearings, this prevents shaft from tearing into drip roll hubs. Adjustable brake gives accurate tension control and prevents drip roll from unwinding freely when machine stops.	\$232.00
16148	DOUBLE DRIP IRRIGATION ATTACHMENT		\$425.00
15850	ADJUSTABLE ROW MARKERS	Fits on all models	\$125.00
15849	CUSHIONED SEAT	Allows a helper to ride along to watch machine and change rolls	\$175.00
3748	FURROW OPENING DISKS	To lay clear plastic over planted sweet corn	\$395.00
15851	FERTILIZER HOPPER	To put granular fertilizer in the row	\$665.00

**Additional Freight will Apply**

# EQUIPMENT



## COMPACT RAISED BED MULCH LAYER



**RB448 with Drip Attachment**



Spring loaded covering disks



With Double Drip



**RB436 with Drip Attachment**

**Designed for use with compact tractors in high tunnels and fields where close spacings are desirable features:** The crowned bed is higher in the center. Teflon-lined bed press gives a smooth, pressed seed bed and eliminates potholes. Adjustable tension on a plastic roll and independent spring-loaded press wheels ensure plastic is stretched tightly. Large cover disks are independently spring-loaded and are fully adjustable to ensure that plastic is covered securely. Drip Irrigation Attachments feature adjustable feed-in tubes and tension adjustment. Flat free/foam-filled press wheels.

### MODEL RB448

ITEM	DESCRIPTION	PRICE
11649	Adjustable to lay 3 or 4 ft. wide plastic, Forms 4" high x 20 or 30" wide bed, 30-60hp recommended.	\$2,260.00
12256	Single Drip Irrigation Attachment for RB448	\$195.00
11650	Double Drip Irrigation Attachment for RB448	\$335.00

### MODEL RB436

ITEM	DESCRIPTION	PRICE
3745	Lays 3 ft. wide plastic, Forms 4" high and 20" wide bed, 20-40hp recommended.	\$1,600.00
12958	Single Drip Irrigation Attachment for RB436	\$195.00
3746	Double Drip Irrigation Attachment for RB436	\$335.00

ITEM	DESCRIPTION	PRICE
14192	Adjustable Row Markers for RB448 or RB436	\$169.95
15540	Dirt shields standard on RB448, Optional on RB436	\$97.75

### STAINLESS STEEL DRY FERTILIZER HOPPER

To incorporate granular fertilizers in the soil under 4' wide plastic mulch. Wheel drives off of plastic roll for consistent fertilizer flow.

**For granular fertilizer. It will not work with powder.** Approximate 100-120 pounds capacity. Adjustable flow, to control fertilizer rate.

*(Fits year 2015 and newer models)*



ITEM	DESCRIPTION	PRICE
13003	SS Fertilizer Hopper for RB448	\$665.00

**Additional Freight will Apply**

Prices are subject to change without notice. Kindly contact us at (508) 273-7358 to verify pricing.



# EQUIPMENT



## WIZARD VACUUM PLANTER



Wizard seed planters are highly user-friendly vacuum seeders with easy seed plate changes, spacing and depth adjustment, and crop changes without tools. The A30 steering handle is adjustable with a safety advancement lever, and the pneumatic drive wheels make transportation between fields easy. Spacing transmission and shoe height adjustment are easily accessible, and seed clean-up is made convenient by a plug at the bottom of the seed hopper. Wizard is one of the most user-friendly precision seed planters available.

Being self-propelled, the Wizard A series seeder is able to cover a lot of ground in a short amount of time. Planting upwards of 2 acres per day is possible with a single operator. Precision planting a wide range of seed sizes sets Wizard apart from similarly priced vacuum seeders which handle either small seeds or large seeds, but not both. Reasonably priced models means smaller operations, hobby farmers, research growers, etc. can now afford the precision vacuum seeding previously exclusive to large-scale commercial growers.

Ideal for planting in greenhouses or open field, Wizard planters are uniquely suited to plant small and large size seeds. The same Wizard seeder can plant small seed crops like carrots, onions, tomato, etc., up to larger seed crops like corn, beans, peas, etc.

Wizard A series units are equipped with a seed bed leveling plate that smooths the soil ahead of the shoe/coulter, assuring more accurate depth control. Row units can be spaced as close as 9.84" (25cm) apart.

ITEM	DESCRIPTION	PRICE
15356	Wizard 3-pt mounted Vacuum Planter	\$5,965.00

**Call for information and pricing | Additional Freight will Apply**



# EQUIPMENT



## CARROUSEL TYPE TRANSPLANTER



### MODEL 5500

The Model 5500 is the most advanced planter available today. A new cam activated plant ejection system, six cup feeder, adjustable shoe and easy adjust patented ski system to eliminate the packing wheels, makes the Model 5500 the fastest and easiest-to-use transplanter on the market.

#### Features

- Movable seats and foot mounts offer rows as narrow as 12". Cam-activated plant ejection eliminates timing requirements and increases speeds
- New adjustable shoe that uses one bolt to easily adjust the shoe width to make it fit most cell sizes
- Easy ski adjustment for quick change "on the go" depth control for any cell size
- Smaller diameter 6-cup feeder increases speed and operator efficiency and has no gaps or spaces for plants to fall between
- Operators weight situated over the toolbar, not the planter
- All planters are driven with our EZ17 drive system for quick change spacing

### MODEL 5500W SERIES - PACKING WHEEL TRANSPLANTERS

The Model 5500W is the base model 5500 with packing wheels for use in no-till, river bottoms or muck conditions. It has all the features of our 5500W planter with our patented float wheel drive system to drive the planter and prepare the soil. The 5500WD 2 comes with barrels and barrel mountings and is equipped with an optional poly double disc shoe and six tray carousel.



Model 5500W



Model 5500WD 2



Model 5500WD B3

**Call for information and pricing | Additional Freight will Apply**







## MECHANICAL TRANSPLANTER FERTILIZER SIDE DRESSER

### FERTILIZER SIDE DRESSER WITH KNIFE OPENERS

This side dresser attachment comes one to eight rows with an individual 300# plastic hoppers for each row. The side dresser is driven by our deluxe roller chain gauge wheel drive system.

**Features:**

- Available with disc openers, knife openers or tubes with sweeps of cultivators
- Gauge wheel drive has 24 different gear combinations for a wide range of fertilizer amounts
- Height can be adjusted to fertilize plants as high as 30"



### THREE ROW SIDE DRESSER WITH CULTIVATORS



### FERTILIZER SIDE DRESSER OPTIONS

ITEM	DESCRIPTION	PRICE
FSD-1 16122	SINGLE HOPPER SIDE DRESSER	\$4,395.00
FSD-2 9421	DOUBLE HOPPER SIDE DRESSER	\$5,470.00
FSD-3 16123	TRIPLE HOPPER SIDE DRESSER	\$6,395.00

ITEM	DESCRIPTION	PRICE
OP5135	PAIR OF KNIFE OPENERS	\$239.00
OP5140	PAIR OF SINGLE DISC OPENERS	\$695.00
FSDC-1	CULTIVATORS for FSD-1	\$645.00
FSDC-2	CULTIVATORS for FSD-2	\$995.00
FSDC-3	CULTIVATORS for FSD-3	\$1,625.00
FSDC-4	CULTIVATORS for FSD-4	\$1,985.00

**Call for information and pricing | Additional Freight will Apply**



# EQUIPMENT

## Dealer for JS Woodhouse Equipment

### SUNDOWN DISK HARROWS



ITEM	SIZE	DESCRIPTION	PRICE
891	4 1/2'	Angle Frame 16" Blade diameter, 12 blades, 20 HP required, 400 lbs.	\$1,550.00
16091	5 1/2'	Angle Frame 16" Blade diameter, 16 blades, 25 HP required, 460 lbs.	\$1,689.00
16092	5 1/2'	Angle Frame 18" Blade diameter, 16 blades, 25 HP required, 500 lbs.	\$2,156.50
16093	6 1/2'	Angle Frame 16" Blade diameter, 20 blades, 30 HP required, 540 lbs.	\$2,175.00
8256	6 1/2'	Angle Frame 18" Blade diameter, 20 blades, 30 HP required, 560 lbs.	\$2,345.00
7126	5'	Box Frame 18" Blade diameter, 16 blades, 30 HP required, 735 lbs.	\$3,290.00
7444	6'	Box Frame 18" Blade diameter, 20 blades, 35 HP required, 735 lbs.	\$3,650.00
5833	7'	Box Frame 18" Blade diameter, 24 blades, 40 HP required, 900 lbs.	\$3,985.00
15656	8'	Box Frame 18" Blade diameter, 28 blades, 45 HP required, 985 lbs.	\$4,445.00

### SUNDOWN FLAIL MOWERS



ITEM	SIZE	DESCRIPTION	PRICE
7201	39"	30-60 HP, 24 knives, 12 hammers, 660 lbs.	\$2,975.00
9256	51"	30-60 HP, 32 knives, 16 hammers, 806 lbs.	\$3,795.00
15537	57"	30-60 HP, 36 knives, 18 hammers, 854 lbs.	\$3,820.00
9685	63"	35-60 HP, 40 knives, 20 hammers, 907 lbs.	\$4,195.00
14240	69"	40-60 HP, 44 knives, 22 hammers, 955 lbs.	\$4,200.00
8502	80"	45-60 HP, 52 knives, 26 hammers, 1060 lbs.	\$4,695.00
13909	87"	50-60 HP, 56 knives, 28 hammers, 1113 lbs.	\$4,975.00
15632	TBD	Optional manual side shift jack.	\$68.95

### SUNDOWN ROTARY TILLERS



16094, 9263, 16121



15993, 4541, 12907



15504, 15586, 15013

ITEM	SIZE	DESCRIPTION	PRICE
16094	36"	15-40 HP, 24 tines, 540 RPM, 6.5" Tilling Depth, 337 lbs.	Light Duty \$2,450.00
9263	42"	20-40 HP, 30 tines, 540 RPM, 6.5" Tilling Depth, 368 lbs.	Light Duty \$2,595.00
16121	48"	20-40 HP, 36 tines, 540 RPM, 6.5" Tilling Depth, 399 lbs.	Light Duty \$2,695.00
15993	60"	25-40 HP, 42 tines, 540 RPM, 6.5" Tilling Depth, 441 lbs.	Light Duty \$2,810.00
4541	65"	35-50 HP, 48 tines, 540 RPM, 7" Tilling Depth, 627 lbs.	Medium Duty \$3,190.00
12907	72"	35-50 HP, 54 tines, 540 RPM, 7" Tilling Depth, 683 lbs.	Medium Duty \$3,800.00
15504	65"	40-65 HP, 42 tines, 540 RPM, 7.5" Tilling Depth, 860 lbs.	Heavy Duty \$3,585.00
15586	72"	45-65 HP, 48 tines, 540 RPM, 7.5" Tilling Depth, 926 lbs.	Heavy Duty \$3,865.00
15013	84"	50-65 HP, 54 tines, 540 RPM, 7.5" Tilling Depth, 990 lbs.	Heavy Duty \$3,745.00



# EQUIPMENT

## SUNDOWN BROADCAST SPREADER, 3 POINT HITCH,



Category 1, 540 rpm. Corrosion proof poly hopper, stainless steel spreading disc with 4 steel vanes. Choice of 3 spread patterns, full center, left or right side. Spreading rates from 30-900 lbs per acre. Optional spread width limiter. Features a strong corrosion proof poly hopper. These spinner units have double levers and stainless steel slides which allow for spreading 180° or 90° to the right or left. They are ideal for even spreading fertilizer, seed, salt, and other flow-able materials, spreading width up to 49'.

ITEM	DESCRIPTION	PRICE
4351	350 lb. capacity, 5.9 cubic ft., 4.7 bushel capacity	\$695.00
4352	650 lb. capacity, 10.4 cubic ft., 8.3 bushel capacity	\$769.85
4880	925 lb. capacity, 13 cubic ft., 11 bushel capacity	\$1,975.00

**PRICES ON ABOVE SUNDOWN SPREADERS ARE ASSEMBLED AND DELIVERED WITHIN OUR DELIVERY AREA.**

## SUNDOWN LANDSCAPE RAKES - STANDARD DUTY



Rakes can be used to pick up trash from the job site, grading driveways and beaches and even grass renovation projects.

Available in the following lengths; 5', 6', 7', and 8'



## SUNDOWN ROTARY CUTTER



ITEM	SIZE	PRICE
12144	48"	\$2,300.00
15654	72"	\$2,800.00

ITEM	SIZE	PRICE
15587	TRAILER MOVER WITH BALL	\$355.00
16049	SUNDOWN 3-POINT FORKS 42"	\$1,295.00



ITEM	SIZE	PRICE
15657	FERRI BOOM ARM MOWER W/ 39" FLAIL HEAD	\$19,952.00
6355	FERRI SLOPE MOWER	\$10,500.00



ITEM	SIZE	PRICE
4993	KIFCO T200L WATER REEL 2" X 580"	CALL FOR PRICING
15901	KIFCO T210L WATER REEL	CALL FOR PRICING

# EQUIPMENT

## ALUMINUM HARVEST CONVEYOR



Aluminum conveyor designed for harvesting vegetables. Including, but not limited to: melons, sweet corn, pumpkins, broccoli, cabbage, and cauliflower. Here are the features that make this conveyor great for the grower that loads directly out of the field:

- Great for packing bins, boxes, or loose on the wagon.
- Mounts right or left and anywhere from front to rear on a regular farm wagon.
- The stand is 16" high and sits on one edge of the wagon. Opposite end clamps to the wagon with a c-clamp attached to a pulley.
- AHC28 has a 3-1/2' long receiving and grading table. 10" wide picking belt with cleats on every foot. The belt travels approximately 50 feet per minute with the tractor at idle. It has a bypass valve and plumbing to stop or slow the belt.
- The bottom belt return track with UHMW strips is standard.
- Easily put on or taken off.
- AHC28 includes a slow-speed high torque hydraulic motor with two 20' long 3/8" hydraulic hoses.
- \* Painted aluminum side prevents discoloration of produce upon contact with the side.



Brusher

### Optional Equipment:

- DROP LID - Removable lid in receiving tables allows produce to fall directly into crates, boxes or bins.
- Available with gasoline engine or 20VDC battery drive motor for use with horse drawn wagons or where hydraulic is not available.
- Standard Cable Winch: This feature makes it easy for one person to adjust the heights as needed due to uneven terrain, etc.

ITEM	DESCRIPTION	PRICE
15876	28' Conveyor with GX120 Engine, Cable Winch & Drop Lid	\$2,995.00
8117	Optional Extension Stand - Raises Conveyor from 16" to 30" above wagon.	\$145.00
15877	Optional hydraulic driver brushes (4-24"). Helps speed cleaning in the field.	\$1,595.00
14528	Harvest Wagon, 8'x18' Proveyor (10 bins)	\$16,995.00
15878	Proveyor 18' Trailer	\$18,500.00
9566	Proveyor Wagon 24'	\$18,950.00
7569	Proveyor 24' Trailer	\$19,750.00

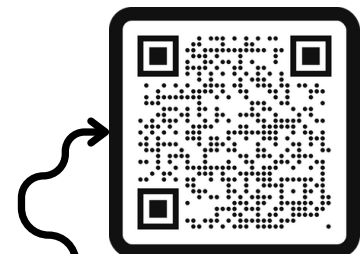

Learn more about the Purveyor Wagon

"We've seen some major efficiencies. We're zipping down those rows. It's been a game-changer for us"  
 -Tangerini Spring Street Farm,  
 Millis, MA



# EQUIPMENT

## JANG JP-1 PUSH SEEDER

- Accurately singulates a wide variety of raw and pelletized seeds with quick change seed rollers and easy adjustments
- Over 40 roller sizes are available for various planting needs
- Weighs 25 lbs.
- Adjustable handle for height and offset
- Quick-release hopper
- Clear plastic hopper to view seed level
- Adjustable depth control
- Hopper volume = 0.26 gal
- Singulates and spaces small seeds, saving time and money
- Seed sizing gauge on hopper lid for ease of roller selection
- No wasted seeds
- Can work with small amounts in the hopper



Rollers are not in stock but are available upon request.

Seed Name/ Seed of Comparable Size	Recommended Roller	Seed Name/ Seed of Comparable Size	Recommended Roller
ARUGULA	YX	LETTUCE (RAW)	XY
BASIL	YYJ	MACHE	F
BEAN-GREEN	N	MUSTARD	YYJ
BEET	LJ	OKRA	LJ
BROCCOLI	Y	ONION (COATED)	MJ
CABBAGE	Y	ONION (RAW)	X
CARROT	Y	PEA	BL
CARROT (COATED)	MJ	PEPPER	MJ
CAULIFLOWER	Y	RADISH	X
CILANTRO	MJ	RUTABAGA	Y
CHIA	YYJ	SORGHUM	MJ
COLLARD	Y	SORGHUM (COATED)	LJ
CORN	A, AA, N	SOY	BL
COTTON	C	SPINACH	F
CUCUMBER	J	SUNFLOWER	Send Samples
CUT FLOWER	Send Samples	SWISS CHARD	LJ
FLAX	LJ	TREE SEED	Send Samples
KALE	X	TURNIP	YYJ

**CALL FOR ROLLER PRICING**

### Spacing Chart for JP Series Seeder

\*Spacing may change due to soil conditions

Number of Teeth in Each Sprocket											
Rear Sprockets		14	14	13	13	11	11	11	10	10	9
Front Sprockets		9	10	10	11	10	11	13	13	14	14
Number of Holes in Seed Roller	3 Hole	20	18	17	15	14	13	11	10	9	8
	4 Hole	15	14	13	12	11	10	8	7.5	7	6
	6 Hole	10	9	8	7.5	7	6.5	5.5	5	4.5	4
	12 Hole	5	4.8	5	4	3.5	3	2.8	2.5	2.5	2
	24 Hole	2.5	2.5	2	2	1.8	1.5	1.3	1	1	0.5

\*Shaded areas show inched between seeds

## HAND PLANTER

This 8 LB. planter allows you to plant directly through plastic. Simply drop the seed into the tube, insert planter through plastic, tilt planter forward to release the seed. Then move down the row, drop another seed and repeat. Adjustable planting depth.



ITEM	DESCRIPTION	PRICE
13143	Hand Planter	\$88.95

ITEM	DESCRIPTION	PRICE
11619	Jang JP-1 Push Seeder	\$519.75
11620	Jang JP-3 Push Seeder	\$1,145.00
11623	Fertilizer Hopper	\$210.00



**13804**

## SEEDER SPREADER

20 Lb. Hopper capacity



**800**

ITEM	DESCRIPTION	PRICE
800	Earthway® Seeder/Spreader	\$55.95
13804	Solo Chest Mount Spreader 421	\$74.95

# EQUIPMENT

## EARTHWAY® GARDEN SEEDER

An ideal row crop seeder; the 1001-B is a tool that takes the guesswork out of planting any row crop. Install one of the seed plates that best fits your seed, then adjust the depth of planting on the ground opener, and then set your 30 long row marker for the desired width, then fill the seed hopper with seeds and you're all set to begin.

Six Standard Seed Plates (included with seeder): ERT10 Sweet Corn, ERT12 Peas, ERT11 Beans, ERT07 Radish, ERT08 Carrots and ERT09 Beets.

Additional Seed Plates: ERT34 Lima Beans, ERT35 Popcorn, ERT39 Broccoli, ERT37 Lettuce & ERT33 Cucumber.

**Fertilizer attachment** for Side Dressing. Easily attaches to all Earthway garden seeders. Applies fertilizer above ground or below to a depth of 2".



ITEM	DESCRIPTION	PRICE
1388	Earthway® Garden Seeder, 12 Lbs.	\$136.55
15395	Earthway® Seeder, 2 row 12" row spacing, 20 lbs. (Can be used separately)	\$320.00
13519	Standard Seed Plate - Set of 5	\$35.50
10694	Additional Seed Plate, Set of 5	\$35.50
12473	Earthway® Fertilizer Applicator Attachment 3 lb	\$80.00
14086	Replacement Belt	\$6.95

## BULB PLANTER

Strong, durable steel with a 30" tubular steel handle. Head is stainless steel and 5-½" deep, punches 2-½" core.



ITEM	DESCRIPTION	PRICE
15839	Bulb Planter	\$49.95

## E-Z BULB PLANTER, HEAVY-DUTY

Spring tension soil release. Push in with hand or foot pressure. Head is 5" deep. Choice of punch diameters.

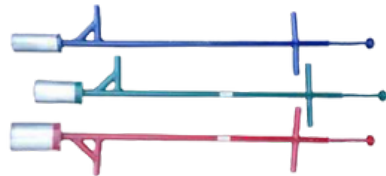

ITEM	DESCRIPTION	PRICE
15840	E-Z Bulb Planter, 2" Blue	\$79.50
15842	E-Z Bulb Planter, 2½" Green	\$79.50
13436	E-Z Bulb Planter, 3" Red	\$79.50

## EARTHWAY® HIGH WHEEL CULTIVATOR

High Wheel Cultivator features steel handles and a 24" steel wheel

**Three standard tools are included:** Five tine cultivator, moldboard plow, and twin-end plow.



ITEM	DESCRIPTION	PRICE
12265	Earthway High Wheel Cultivator	\$149.95
11926	Optional Weed Slicing Hoe, 2 Lb.	\$53.65
15838	Kentucky Style OAK wooden handle kit	\$112.95

**A FREIGHT CHARGE MAY APPLY TO THE PRICES LISTED ABOVE.**



# EQUIPMENT

## MEDIA MASTER™ POT & FLAT FILLER

This versatile machine features both a bale buster and a pot/flat filler. Requires single phase 230VAC. Pre-wired with plug. Full load: 14 amps.

**Pot/Flat Filler Features:** Fills pots/flats up to 14" wide and up to 12" tall. The leveler assembly height is easy and quick to adjust via a winch. Distribution chute is adjustable to evenly fill the pots & trays. Water-resistant control panel features variable speed controls for the conveyer and for the supply auger.

**Capacity:** 21 cu. Ft. Loose (3=3.8 cu. ft. compressed bales). Thorough mixing allows you to add additional products to your mix (root shield, fungicide, etc).

**Fill Height:** 34".

**Dimensions:** 113" width x 48" depth x 70" height.

**Shipping Weight:** approx.950 lbs.



ITEM	DESCRIPTION	PRICE
14019	Model 2100 Pot/Flat Filler	\$10,955.45



Rearview

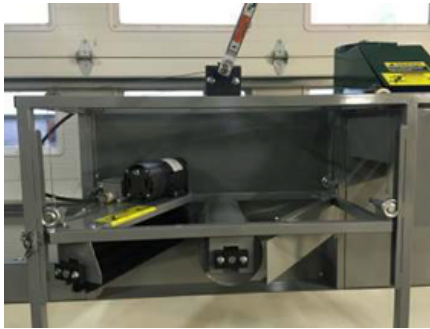

Leveling Roller and Brush Assembly

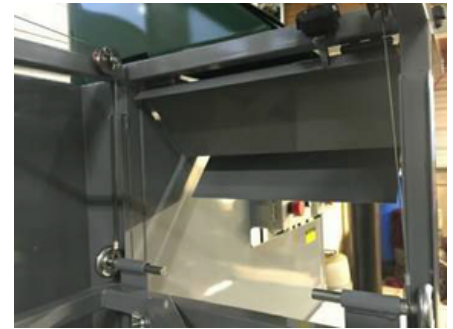

Adjustable Distribution Chute

## MEDIA MASTER™ BALE BUSTER

**Bale Buster Features:** A series of rotating arms that quickly and thoroughly mix and loosen soil in less than a minute. Thorough mixing allows you to add additional product to your mix (root shield, fungicide etc). Convenient fill height of 34". The supply auger & filling chute allows you to easily fill pots and trays manually. Variable speed controls are optional, however typically not needed.

**Requires single phase 230VAC.** Pre-wired and ready to plug in.

**Hopper Capacity:** of 14 cu. ft. loose (2=3.8 cu. Ft. comp. bales).

**Full Load:** 10.3 amps.

**Dimensions:** 54" width x 48" depth x 69" heights.

**Shipping Weight:** about 675 lbs.

ITEM	DESCRIPTION	PRICE
11722	Model 1400 Bale Buster	\$6,995.00



Mixing Arms



Filling Auger and Chute



**Additional Freight will Apply**

# EQUIPMENT

## SOLO 475 BACKPACK SPRAYER 4 GALLON DIAPHRAGM

The model 475 is a durable and UV-protected high-density polyethylene tank with a large opening, filter basket, shut-off valve, and wand with a length of 28". It comes with 4 feet of high-pressure hose and padded shoulder straps for comfort. Capable of producing up to 60 psi, it features a rugged connecting rod-actuated diaphragm pump made of high-quality Viton, which can handle chemicals in wettable powder and liquid formulations without getting damaged by small abrasive particles.



ITEM	DESCRIPTION	PRICE
2570	SOLO 475 BACKPACK DIAPHRAGM SPRAYER 4 GAL	\$98.95

## SOLO 425 BACKPACK SPRAYER, 4 GAL PISTON

High-performance piston pump for increased pressure capabilities. Extra large (4.25in) opening for easier filling & cleaning. 28" unbreakable wand & shut off valve. 48in high-pressure hose. Padded shoulder straps.



ITEM	DESCRIPTION	PRICE
13783	SOLO 425	\$98.95

## SOLO 430 HANDHELD SPRAYER

Designed for general purpose spraying. Viton seals, long hose, large pump handle and funnel top for easy filling. Includes an assortment of four nozzles. Adjustable for spraying stream to a mist; Flat Fan for area and row application; Hollow Cone for shrubs and bushes; and Jet Stream for additional reach.



ITEM	DESCRIPTION	PRICE
5051	2 GALLON	\$33.95

## SOLO 417 BACKPACK SPRAYER, 4.5 GAL BATTERY OPERATED

11V 7.2Ah lithium-ion battery, with a 4.5-gallon tank. The Solo 417 has 2 speed pump for optimal pressure control, with settings at 36 psi and 62 psi.



ITEM	DESCRIPTION	PRICE
12986	SOLO 417	\$246.75

## SOLO 433 5 GALLON, GAS POWERED, SPRAYER

Gas powered 5 gallon motorized sprayer. The 435 psi capacity of this sprayer allows for fine mist application at a minimum flow rate of 0.5 gpm.



ITEM	DESCRIPTION	PRICE
12392	SOLO 433	\$698.25

## SOLO 466 3.7 GALLON, GAS POWERED, MIST BLOWER

Gas powered 3 gallon motorized mist blower. 66.5 cc engine with nickel/silicone carbide cylinder coating to generate a fan air volume of max 824 CFMs for total operating conditions.



ITEM	DESCRIPTION	PRICE
1918	Solo 466	\$599.50

**WE CARRY AN EXTENSIVE SUPPLY OF SOLO SPRAYERS AND REPLACEMENT PARTS. PLEASE INQUIRE AND WE WILL ASSIST YOU IN FINDING THE RIGHT PRODUCT.**

## BATTERY OPERATED 12V SPRAYERS

**All Units Feature:** 12V Shurflo pump set at 100 PSI. 15' Hose with spray gun. Angled swivel nozzle, stream to mist. Connected wire leads with fused switch.

**Spray Caddy:** Battery-powered unit on 10" wheels. Includes 12V battery and unregulated charger that prevents overcharging the battery. A convenient six gallon container that lifts out to fill and clean. Sprays approx. 18 gal / charge.

**Portable Sprayers:** Yellow tank (15 or 25 gal.), same components as spray caddy. Connects to 12 Volt battery. Ideal to mount on a garden cart, ATV, etc.

ITEM	CAPACITY	PRICE
13739	SPRAY CADDY, 6 GAL. TANK	\$398.45
15271	RECHARGABLE BATTERY 12V	\$36.00
15272	12V CHARGER FOR SPRAY CADDY	\$19.95
1477	PORTABLE SPRAYER. 15 GAL. TANK	\$219.75
4387	PORTABLE SPRAYER, 25 GAL. TANK	\$309.95





# EQUIPMENT

## DRAMM® MINI AUTO FOG™

The Dramm Mini AutoFog is a low-volume chemical applicator designed for smaller greenhouses. It can automatically treat 5,000 sq. ft. with a highly concentrated spray solution, using a specially designed nozzle to generate micro-particles that ensure complete and even coverage of plant surfaces. This method reduces run-off and the amount of chemicals needed. It features a 24-hour timer, durable oilless compressor, and mechanical agitation to keep chemicals in suspension.

**Standard Treatment Area:** Up to 5,000 sq. Ft. (7,000 sq ft with circulation fans)

**Nozzle:** Air atomizing, outputs 8 liters in 4 hours.

**Adjustable Nozzle Height:** 5-7 ft.

**Tank Size:** 8 Liters (8.45 quarts)

ITEM	DESCRIPTION	PRICE
15760	110 Volt Mini AutoFog with SS Nozzle	\$4,685.00
15387	Dramm Autofog SLVH-20A Fogger	\$8,795.00



## FOGIT GREENHOUSE SPRAYER

The Fogit Sprayer is an easy-to-use, low-volume chemical applicator designed with smaller greenhouses in mind. It can easily apply various chemical formulations using a highly concentrated spray solution. The nozzle generates micro-particles that fill the entire treatment area and ensure complete and even coverage of all plant surfaces. This method of applying chemical solutions eliminates costly run-off and reduces the amount of chemical.

**Standard Treatment Area:** Up to 5,000 sq. Ft. (7,000 sq ft with circulation fans).

**Tank Size:** approx. 7 Liters (7.4 quarts)

**Compressor Required:** CFM at 25 PSI (9 CFM for dual head)

**Now Standard with stainless steel head(s) and larger tank**

ITEM	DESCRIPTION	PRICE
15771	Fogit Greenhouse Sprayer, Single Nozzle	\$489.65
15772	Fogit Greenhouse Sprayer, Double Nozzle	\$592.35



## DRAMM® K-10 PORTABLE PULSFOG®

Perfect for the application of insecticides, fungicides, and disinfectants.

Propels chemical: 45 ft with NutriFog, 100 ft with VK-1 (more with the help of circulation fans)

**PULSFOG® DILUENT SOLUTIONS** best results; the PulsFOG requires carrier solutions or fog enhancers. These solutions help to create a more even particle size, distribute the solution throughout the area, and retard the evaporation of fog droplets. Some chemicals may not require additional carrier solutions due to their formulation. Check with your chemical supplier for more in-depth information.



ITEM	DESCRIPTION	PRICE
15762	25 HP 2.6 Gallon Thermo Fogger	\$3,700.00

## NutriFOG



For best results, the PulsFOG requires the use of carrier solution. It helps to create more even particle size, distribute the solution throughout the area, and retard evaporation of fog droplets. This carrier is a 10-3-3 Foliar Fertilizer. It can be used with all chemical formulations. It is safe on ornamentals, fruits & vegetables. Do not use more than five times in one month on the same crop.

### Rates for NutriFOG:

- 0.25 Quart NutriFOG Solution
- 1.75 Quarts Water
- Apply above mix into 10,000 square feet of area

ITEM	DESCRIPTION	PRICE
15763	NutriFOG, 5 gallon pail	\$440.00

## SUNDSTROM MASKS

SR100 & SR200 masks are Air Purifying Respirators (APR) made of silicone. The mask is equipped with two exhalation valves, which ensures very low exhalation resistance. The mask is used with SR307 compressed air attachment, this combination is called a Type C Continuous Flow Supplied Air Respirator (SAR).

### PRO-PACK SR100

1/2 Face Mask Respirator



ITEM	DESCRIPTION	PRICE
10470	SMALL/MEDIUM	\$63.95
10471	MEDIUM/LARGE	\$63.95
10472	LARGE/XLARGE	\$63.95

### PRO-PACK SR200

Full Mask Respirator



ITEM	DESCRIPTION	PRICE
10469	ONE SIZE	\$240.90

### SAFETY GOGGLES



ITEM	DESCRIPTION	PRICE
288	ONE SIZE	\$5.00

### LATEX DISPOSABLE GLOVES

Textured, powdered, rubber latex disposable gloves. Food grade. Non-medical use only. 100 per box



ITEM	DESCRIPTION	PRICE
15025	MEDIUM	\$9.00
15026	LARGE	\$9.00
15027	EXTRA LARGE	\$9.00

### BLACK PVC GLOVES

Cotton Lined, 12"



ITEM	DESCRIPTION	PRICE
11157	ONE SIZE	4.00

### COVERALLS

Kimberly-Clark® KLEENGUARD® A20

ITEM	DESCRIPTION	PRICE
15028	Blue Hooded Coveralls, Large	\$9.99
15029	Blue Hooded Coveralls, X-Large	\$9.99





# GREENHOUSE SUPPLIES

## TUFFLITE® GREENHOUSE PLASTIC

Manufactured by Berry Plastics, Tufflite products offer high clarity to allow the most light possible. They also feature tri-layer extrusion and dust resistance.

TUFTLITE IV™, CLEAR, 6 MIL, 4 YEAR					
ITEM	DESCRIPTION	PRICE	ITEM	DESCRIPTION	PRICE
3464	14' x 100'	\$138.00	14658	20' x 150'	\$290.00
3187	20' x 100'	\$194.00	4391	24' x 150'	\$370.00
4452	24' x 100'	\$240.00	11502	32' x 150'	\$480.00
4350	28' x 100'	\$280.00	11503	36' x 150'	\$540.00
3463	32' x 100'	\$320.00	4265	40' x 150'	\$594.00
14657	36' x 100'	\$360.00	4240	48' x 150'	\$720.00
2658	40' x 100'	\$396.00	10340	50' x 150'	\$740.00
4127	42' x 100'	\$425.00	11504	56' x 150'	\$810.00
2660	48' x 100'	\$480.00			
10339	50' x 100'	\$480.00			
13930	56' x 100'	\$540.00			

KLERKS PLASTIC ALSO AVAILABLE, CALL FOR PRICING

## NURSERY CLEAR™

4 mil, 1 year

ITEM	DESCRIPTION	PRICE	ITEM	DESCRIPTION	PRICE
10777	24' x 100'	\$136.00	3642	24' x 150'	\$208.00
2757	32' x 100'	\$178.00	12490	32' x 150'	\$270.00
2756	40' x 100'	\$220.00	13823	40' x 150'	\$230.00

## KLERKS KOOL LITE PLUS

This 4-year, 6 mil, UV stabilized covering allows 84% light transmission, yet lowers greenhouse air temperature by 10 degrees compared to traditional greenhouse films. Also features light diffusion (53%), 2 sided anti-condensate, and IR additives that re-radiate nighttime infrared heat.



ITEM	DESCRIPTION	PRICE	ITEM	DESCRIPTION	PRICE
11518	32' x 100'	\$440.00	11522	32' x 150'	\$653.00
11519	36' x 100'	\$500.00	11523	36' x 150'	\$735.00
11520	42' x 100'	\$580.00	11524	40' x 150'	\$880.00
11521	48' x 100'	\$670.00	11525	42' x 150'	\$1,000.00

## KOOL RAY CLASSIC SHADE, 1 GALLON

Concentrated liquid shade. The common dilution rate is 1 part to 8 parts water, which reduces light transmission by 31%. A 1:3 ratio reduces light by 45%. A 1:1 ratio reduces glare by 65%. One gallon of solution covers 175 sq. ft. Can be applied by brush, roller, or spray, but works best when spray is applied. Usually applied in spring or summer, then during the course of the year, the shading will slowly wear off for increased light levels as the daylight increases. Frost will also loosen shade. Keep product from freezing.



ITEM	DESCRIPTION	PRICE	4+
10871	Kool Ray, Liquid Shade	\$48.75	\$47.75

## INFRARED™

A 4-year, 6 mil, energy-saving greenhouse covering. Features Drip-Less™ technology and an additive that retains infrared waves, improving nighttime heat retention. Also, light diffusing-reduces shadows. Use for the bottom layer in a layer

TUFTLITE IV™, CLEAR, 6 MIL, 4 YEAR					
ITEM	DESCRIPTION	PRICE	ITEM	DESCRIPTION	PRICE
4453	20' x 100'	\$214.00	14654	20' x 150'	\$322.00
4454	24' x 100'	\$258.00	11508	32' x 150'	\$510.00
4491	28' x 100'	\$296.00	11509	36' x 150'	\$588.00
3183	32' x 100'	\$340.00	15678	40' x 150'	\$640.00
14653	36' x 100'	\$390.00	11510	42' x 150'	\$660.00
3184	40' x 100'	\$422.00	4239	48' x 150'	\$746.00
10192	42' x 100'	\$436.00	11511	50' x 150'	\$796.00
2755	48' x 100'	\$496.00	11512	56' x 150'	\$890.00
11506	50' x 100'	\$530.00			
11501	56' x 100'	\$592.00			

## WHITE COPOLY, 70% SHADE

A 4mil. 1 season, greenhouse cover. Can be used for over-wintering, often used for dormant or on storage structures

ITEM	DESCRIPTION	PRICE	ITEM	DESCRIPTION	PRICE
11513	24' x 100'	\$140.00	11515	24' x 150'	\$200.00
4951	32' x 100'	\$188.00	11516	32' x 150'	\$282.00
11514	40' x 100'	\$220.00	11517	40' x 150'	\$330.00

## BLACK KNITTED SHADE CLOTH, 50% SHADE

100% UV stabilized polyethylene with a lock stitch construction that keeps edges from unraveling. The material to be cut to exact size on job site with household scissors. "Clip-its" for 4ft spacing, on length of both sides are supplied at no extra charge

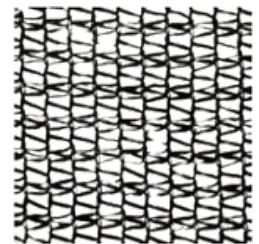

ITEM	DESCRIPTION	1-94'	95'+
12303	26' Shade Cloth, 50% Black Knitted	\$4.45	\$4.05
12487	34' Shade Cloth, 50% Black Knitted	\$5.39	\$5.00

OTHER WIDTHS AND SHADE % AVAILABLE

## PLASTIC CLIP-ITS

Folds & clamps to secure shade cloth

ITEM	DESCRIPTION	PRICE
4277	Plastic Clip-its	\$0.27



# GREENHOUSE SUPPLIES

## POLY PATCH GREENHOUSE TAPE

A rugged patching tape for preventive maintenance in areas of extra stress and is perfect for mending greenhouse rips and tears. Clear, polyethylene tape with a medium tack acrylic-based adhesive with a white poly coated release



ITEM	DESCRIPTION	PRICE
12491	Poly Patch Tape 2" x 48'	\$9.85
2770	Poly Patch Tape 4" x 48'	\$17.95
2769	Poly Patch Tape 6" x 48'	\$26.95

## INFLATION FAN

Brushless 12VDC, 0.22A (2.64 W) fan. Inflation unit includes a wirelock frame and to connect to battery. 77 CFM

ITEM	DESCRIPTION	PRICE
11526	12VDC Muffin Fan Inflation Unit	\$81.00
11527	Replacement 12 Muffin Fan	\$35.00
14736	110VAC Muffin Fan Inflation Unit	\$35.00

## INFLATION BLOWERS

For inflation doubled layered film on greenhouses 120 VAC, pre-wired with 8 ft cord



ITEM	DESCRIPTION	PRICE
3465	3 Bolt Blower, 60 CFM, 0.15A (18 W)	\$61.95
3466	3 Bolt Blower Mounting Kit	\$18.95
2921	4 Bolt Blower, 148 CFM, 0.5A (60 W)	\$85.00
3467	4 Bolt Blower Mounting Kit	\$17.50

## OUTSIDE INFLATION UNIT

Used to inflate the air space between polyethylene walls of your greenhouse, the 60 CFM motor can be used for spaces up to 2,200 sq ft. The 148 CFM motor can be used for spaces larger than 2,200 sq ft.

Replacement Blower Motors come pre-wired with a grounded plug, no hard-wiring required.



ITEM	DESCRIPTION	PRICE
12905	Outside Air Kit for 3 bolt Blower	\$48.95
14151	Outside Air Kit for 4 bolt Blower	\$48.95

## GREENHOUSE SPACER BLOCK

These spacer blocks are used to create an air layer between two layers of poly without the need for an inflation blower or electricity. They are commonly used where electricity is unavailable.



ITEM	DESCRIPTION	PRICE	100+
11489	Greenhouse Spacer Block	\$6.29	\$6.00

## AIR JUMPER TUBE

Air jumper tubes with twist coupling ends. Used to jump air from main inflated part to side curtains and endwalls.

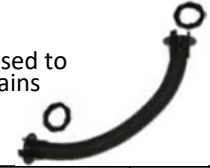

ITEM	DESCRIPTION	PRICE
4262	24" Air Jumper	\$16.95
4263	48" Air Jumper Tube	\$17.85

## WIRELOCK POLY FASTENER

Poly fastener system that also works with shade cloth, insect and bird netting, etc. ZigZag wires lock the material in the Wirelock channel. Can be used to splice poly. Can be formed on the top of curved bows. Holds 4 layers poly and 2 layers of ZigZag wire.

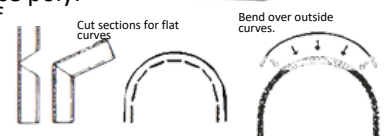

ITEM	DESCRIPTION	PRICE	20+	60+
4213	8' Aluminum Single Wirelock	\$7.95	\$7.45	\$6.95
4128	12' Aluminum Single Wirelock	\$10.95	\$10.45	\$10.00

## END BOW WIRELOCK

Used on end bow to secure plastic and protect top of endwall.

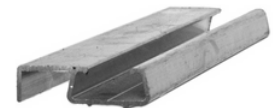

ITEM	DESCRIPTION	PRICE
11497	12' End Bow Wirelock	\$19.85

## DOUBLE WIRELOCK

Commonly used at the the top of roll up sides which eliminates the need to run a supporting board vs single Wirelock. Splice plates included. Order ZigZag wire separately



ITEM	DESCRIPTION	PRICE	8+
10203	8' Aluminum Double Wirelock	\$17.95	\$16.65
11895	12' Aluminum Double Wirelock	\$26.95	\$25.25

## ZIGZAG WIRE

For use with wirelock poly fasteners. Our Zigzag wire is made from .085" diameter, heavy duty, stainless steel spring wire, double tempered to allow for a better return to original shape.

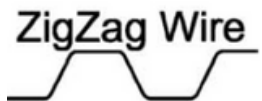

ITEM	DESCRIPTION	PRICE
4129	4' ZigZag Wire	\$1.25
13379	4' ZigZag Wire/50 Bundle	\$51.00



# GREENHOUSE SUPPLIES

## POLYCARBONATE SHEETING

Clear twin-wall 8 MM polycarbonate sheeting. The perfect glazing choice for any greenhouse covering, translates its many unique features into cost saving benefits. Heavy Gauge - Increased strength. Improved hail protection. Anti-Fog - prevents condensation buildup. Improved light transmission. 10 year warranty. Install with UV protected side toward exterior!



ITEM	DESCRIPTION	PRICE	100+
4615	4' x 8' Polycarbonate Sheet, 8MM	\$46.65	\$45.00
11491	4' x 10' Polycarbonate Sheet, 8MM	\$56.00	\$53.00
5083	4' x 12' Polycarbonate Sheet, 8MM	\$67.00	\$63.00
11492	4' x 14' Polycarbonate Sheet, 8MM	\$72.00	\$70.00
10140	4' x 16' Polycarbonate Sheet, 8MM	\$90.00	\$88.00

*We can custom order any length sheets (maximum 48').*

## ALUMINUM EXTRUSIONS FOR POLYCARBONATE

For 8 MM Polycarbonate sheeting. Double H is used to join two pieces. Single H is used to hold down edge or cover

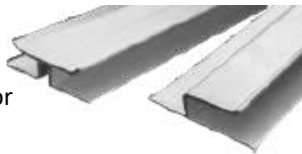

ITEM	DESCRIPTION	PRICE	20+
11493	12' Double H Extrusion	\$15.80	\$14.80
10142	12' Single H Extrusion	\$12.50	\$11.40

## METAL PIPE STRAPS

These heavy-duty, 3 hole metal pipe straps are used to fasten purlins, windbraces, baseboards, etc. Has a predrilled hole on the round part of the strap for a third tek screw to keep it from sliding.



ITEM	DESCRIPTION	PRICE	50+
10008	1-3/8" Pipe Strap, fits 1.315" OD pipe	\$0.59	\$0.49
10004	1-5/8" Pipe Strap, fits 1.66" OD pipe	\$0.75	\$0.69
11581	1.9" Pipe Strap, fits 1.9" OD pipe	\$0.82	\$0.70
14737	2-3/8" Pipe Strap, fits 2.375" OD pipe	\$0.95	\$0.79

## CROSS CONNECTORS

Don't Drill! Cross-Connect! Unique, 2-piece aluminum connector retains 100% of your frame's strength.



ITEM	DESCRIPTION	PRICE	50+
10003	Connects 1.315" to 1.315" pipe	\$2.25	\$2.00
11579	Connects 1.315" to 1.66" pipe	\$2.30	\$2.05
11580	Connects 1.315" to 1.9" pipe	\$2.40	\$2.10
15793	1/4" Bolts & Nuts only for Cross Connectors	\$0.15	

## TAPE AND WASHERS FOR POLYCARBONATE

**10145** is a 1" neoprene/metal bonded washer used with fasteners to secure polycarbonate. Aluminum **11495** tape can close the top, while vent tape covering the bottom removes bugs and dirt and allows water to drain and air to circulate.



ITEM	DESCRIPTION	PRICE
10145	1" Metal/Neoprene Washers, 100/bag	\$12.00
11495	2" x 150' Aluminum Foil Tape	\$13.55
11496	1 1/2" x 108' Vent Tape	\$37.50

## WHITE FELT TAPE

White, 1/8" thick felt with an acrylic-based adhesive. Use to cover sharp edges or rough surfaces. Protects greenhouse hoops and components from wearing and tearing greenhouse film.

ITEM	DESCRIPTION	PRICE
11490	White Felt Tape 1 1/2" x 48'	\$18.95

## WHITE VINYL BATTEN TAPE

For securing plastic film to end walls, wood frame greenhouses, cold frames, etc. Just staple every 3-4" holding tape tight. 3/4" wide x 1/32" thick, 500 ft roll.

ITEM	DESCRIPTION	PRICE
4773	3/4" x 500' Batten Tape	\$42.95

## SLIDE CLAMPS

This 3" wide pipe strap, no holes, is used for attaching double Wirelock to greenhouse arches.



ITEM	DESCRIPTION	PRICE
11498	1 1/8" Slide Clamp fits 1.315" OD pipe	\$2.00
11499	1 5/8" Slide Clamp fits 1.66" OD pipe	\$2.00
11500	2" Slide Clamp fits 1.9" OD pipe	\$2.25

# GREENHOUSE SUPPLIES

## STAINLESS STEEL SCREWS

Tek Screws Hex head. Self drilling into metal.



ITEM	DESCRIPTION	BAG QTY	PRICE
12492	#10 x 3/4" SS Tek Screw	100/BAG	\$11.75
11594	#12 x 1" SS Tek Screw	100/BAG	\$13.75
11595	#12 x 1 1/2" SS Tek Screw	100/BAG	\$16.85
11596	5/16" Hex Driver Bit for above	N/A	\$2.25
11597	#14 x 1" SS Tek Screw	50/BAG	\$15.50
11598	3/8" Hex Driver Bit for above	N/A	\$ 2.90

## TEK SCREWS

Tek Screws Philips head. Self drilling into metal.



ITEM	DESCRIPTION	BAG QTY	PRICE
12513	#10 x 1 1/2" Philips Tek Screw	100/BOX	\$23.00

## WOOD SCREWS

with Washer 1/4" Hex head.



ITEM	DESCRIPTION	BAG QTY	PRICE
11600	#9 X 1 1/2" Wood Screw	250/BAG	\$39.00
11601	1/4" Hex Driver Bit for above	N/A	\$2.80

## DECK SCREWS

Star drive, no slipping. Bit included in each box.



ITEM	DESCRIPTION	1LB BOX	PRICE	5+
11602	#9 x 1 1/2" Deck Screw	167 PIECES	\$23.95	\$22.50
11603	#9 x 2" Deck Screw	124 PIECES	\$23.95	\$22.50
11604	#9 x 2 1/2" Deck Screw	86 PIECES	\$23.95	\$22.50

## SQUARE GALVANIZED TUBING

This steel square tubing has a heavy-duty galvanized coating for long-term rust and corrosion protection. Uses include: **framing greenhouse gable ends**, greenhouse benches, doors, etc.



ITEM	DESCRIPTION	PRICE
13935	1 1/2" x 24' long, 16 gauge	\$40.00
11658	1-3/4" x 13'-4" long, 14 gauge	\$41.75

## BLACK NYLON CABLE TIES

UV Treated

ITEM	LENGTH	TENSILE STRENGTH	MAX BUNDLE DIAMETER	BAG QTY.	PRICE
13999	5"	40 LBS	1.25"	100/BAG	\$3.95
14453	8"	40 LBS	2"	100/BAG	\$4.50
13594	11"	50 LBS	3"	100/BAG	\$5.95
14738	14"	120 LBS	4"	100/BAG	\$9.45

## SPLICER FOR SQUARE TUBING

Fits inside square tubing. Secure with tek screws

ITEM	DESCRIPTION	PRICE
11583	Coupler for 1 3/4" Square Tubing	\$2.95
14739	Coupler for 1 1/2" Square Tubing	\$3.25

## METAL END WALL ANGLE

Ell for connecting square tubing at right angles. Angle is 1 1/2" x 2" with three holes for fasteners. Fasten with #14 x 1" Tek screws.

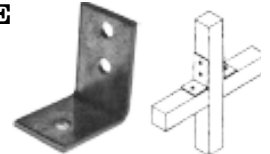

ITEM	DESCRIPTION	PRICE	25+
11584	Metal End Wall Angle	\$0.59	\$0.50

## BRACE BANDS



ITEM	DESCRIPTION	PRICE
11585	1.315" Brace Band	\$0.75
11586	1.66" Brace Band	\$0.78
10164	1.90" Brace Band	\$0.83
15774	2-3/8" Brace Band Beveled	\$0.85
14740	5/16" Brace Band Galv. Nut	\$0.12
14741	5/16" X 1 1/2" Brace Band Galv. Carriage Bolt	\$0.35

## END WALL FRAMING BRACKETS

Used to attach end wall framing to the gable end arch. Works with any wood or metal square tubing end walls. Size indicates the size of the brace band, match to your arch size.



ITEM	DESCRIPTION	PRICE
10005	1.315" End Wall Framing Bracket	\$3.75
11587	1.66" End Wall Framing Bracket	\$3.85
11588	1.9" End Wall Framing Bracket	\$3.95

## EXTENSION HANGERS

### Heavy-duty S-hooks

Made from 10 gauge galvanized steel, these S-hooks can hold up to 35 pounds. 13/s" hooks on each end.

ITEM	DESCRIPTION	PRICE
11589	6" S-hooks, 100/Box	\$26.50
4899	12" S-hooks, 100/Box	\$30.50
11590	15" S-hooks, 100/Box	\$35.00
10451	18" S-hooks, 100/Box	\$38.00
10319	24" S-hooks, 100/Box	\$45.00
11592	30" S-hooks, 100/Box	\$53.00
4900	36" S-hooks, 100/Box	\$59.00

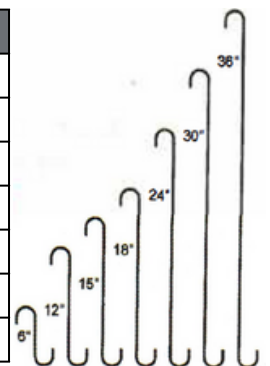



# GREENHOUSE SUPPLIES

## GREENHOUSE ROLL UP SIDES

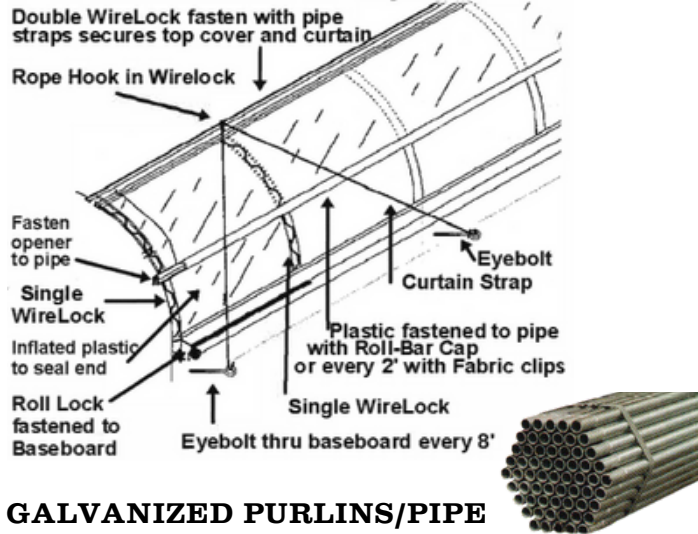

## GALVANIZED PURLINS/PIPE

ITEM	Description	PRICE	25+
11540	0.922" x 10' Purlin, 3" swedge, 18 gauge Put on top of crossties for hanging baskets	1-24 \$10.00	CALL
3639	1.315" x 12' Purlin, 3" swedge, 17 gauge For roll-up pipe, purlins, etc	1-9 \$14.40	10+ CALL
11541	1.66" x 24' Purlin, 3" swedge, 13 gauge For ground stakes or HD purlin	FULL 24' PC \$41.00	
11542	1.9" x 24' Purlin, 13 gauge, no swedge For ground stakes	FULL 24' PC \$69.65	

## ROLL BAR CAP

Securely holds single or double layer plastic to 1.315" OD. roll pipe. Fasten with #12 x 1" Tek screws every 12"

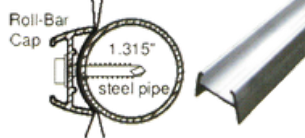

ITEM	DESCRIPTION	PRICE	20+
10196	8" Roll Bar Cap	\$6.75	CALL

## ALUMINUM FABRIC CLIPS

Fastening plastic or shade cloth to pipe is a snap with fabric clips. Space every 2' on roll pipe.

ITEM	DESCRIPTION	PRICE	20+
11569	¾" Fabric Clip, fits 0.92" OD pipe	\$1.35	\$1.30
11570	1" Fabric Clip, fits 1.315" OD pipe	\$0.90	\$0.85
11571	1¼" Fabric Clip, fits 1.66" OD pipe	\$1.06	\$1.03

## SIDE CLASP ROLL BAR

Posi-Clasp's 2" OD aluminum Side Clasp Roll Bar is the "all-in-one" roll bar. This roll bar can be used on curtain systems up to 200'. Works great with Roll-Lock. The SCR uses Zig-Zag Wire (not included) to clasp one or two layers of curtain material into the built-in WireLock groove, allowing it to maintain its round shape as the curtain is rolled up. Comes with square splicer that keeps roll bar from twisting.



ITEM	DESCRIPTION	PRICE	20+
10994	12' Side-Clasp Roll Bar w/ Splicer	\$37.50	CALL

## ALUMINUM ROLL-LOCK

The Posi-Clasp Roll-Lock extrusion, creates a fully secured seal at the bottom of the roll up sides. Because of its superior seal it is recommended to use on heated structures. Enhances wind control and extends poly life. Splice plates are included.



ITEM	DESCRIPTION	PRICE	6+
11572	8' Aluminum Roll-Lock	\$36.95	CALL
11573	12' Aluminum Roll-Lock	\$56.95	CALL

## ROLL PIPE INSTALLATION AIDS

Hangers (11574 & 11575) make roll bar installation quicker, easier & more uniform. Pipe hanger sets uniformly support 96' feet of roll pipe during installation. Hangers can be moved along greenhouse as installation progresses. Roll pipe deflector is for 2" baseboard. Install when not using Roll-Lock to deflect roll pipe out over edge of baseboard.

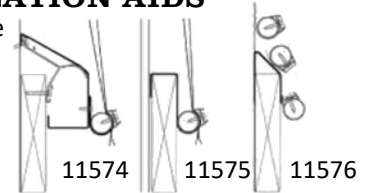

ITEM	DESCRIPTION	PRICE
11574	1.315" Pipe Hanger, Roll-Lock, set of 9	\$44.95
14742	Side Clasp Hanger, Roll-Lock, set of 9	\$44.50
11576	Pipe Deflector for 2" baseboard, set of 9	\$21.95
11575	Roll Pipe Hanger, fits 2" baseboard, set of 9	\$23.50

## ZINC EYE BOLTS & SCREWS

ITEM	DESCRIPTION	PRICE
10194	5/16" x 3" Eye Bolt, for baseboard w/o Roll Lock	\$1.00
14743	3/8" x 8" Eye Bolt, for baseboard w/ Roll Lock	\$2.00
11972	5/16" x 4" Eye Screw, for baseboard w/o Roll Lock	\$0.95

## CURTAIN ROPE & ROPE HOOK

Black Braided Curtain Rope, ¾", 100% polyester. Aluminum Rope Hook inserts into WireLock without fasteners. Open hook for 1/4" rope.



ITEM	DESCRIPTION	PRICE
10237	1/4" x 350' Black Curtain Rope	\$41.95
10193	Aluminum Rope Hook, Pack of 25	\$26.50

## CURTAIN STRAPPING

ITEM	DESCRIPTION	PRICE
11577	2" x 600' Black Curtain Strapping, UV resistant	\$52.00

## HANDHELD POLY SEALER

Seal 2 layers of poly together at curtain ends to allow roll up sides to inflate. Required for automatic inflation of Roll Up/Lockdown Systems that use the RollLock extrusion. Features: 6" sealing length with teflon coated jaws. Seals PE, PVC, Cello, Mylar, and more. 115 volt, 25 watt



ITEM	DESCRIPTION	PRICE
11578	Handheld Poly Sealer, 6" jaws	\$125.75

# GREENHOUSE SUPPLIES

## GREENHOUSE DOORS

Greenhouse doors are ready to install. High-quality aluminum construction with two polycarbonate windows.

**Optional:** Tempered glass for top window.

**Allow 6-10 weeks lead time.**

Single Sliding: Optional - add \$18.00 for Bottom Seal Brush					
ALL POLYCARBONATE			WITH TEMP. GLASS TOP HALF		
ITEM	DESCRIPTION	PRICE	ITEM	DESCRIPTION	PRICE
14753	3' x 7'	\$660.00	14756	3' x 7'	\$680.00
14754	3' x 8'	\$715.00	14757	3' x 8'	\$725.00
12277	4' x 7'	\$695.00	14758	4' x 7'	\$735.00
14755	4' x 8'	\$745.00	14759	4' x 8'	\$785.00

**Includes:** Standard Latch, Brushes (two sides & top), Aluminum Track & Rollers, 2 Pull Handles, 1 Stay Roller, and 1 Door Guide

Double Sliding: Optional - add \$36.00 for Bottom Seal Brush					
ALL POLYCARBONATE			WITH TEMP. GLASS TOP HALF		
ITEM	DESCRIPTION	PRICE	ITEM	DESCRIPTION	PRICE
14760	3' x 7'	\$995.00	14762	3' x 7'	\$1075.00
14761	3' x 8'	\$1065.00	14763	3' x 8'	\$1150.00
13281	4' x 7'	\$1095.00	14767	4' x 7'	\$1180.00
11754	4' x 8'	\$1185.00	14768	4' x 8'	\$1295.00

**Includes:** Standard Latch, Brushes (two sides & top), Aluminum Track and Rollers, 4 Pull Handles, 2 Stay Rollers, 1 Cane Bolt, 1 Door Stay and Fasteners.

Single Hung					
ALL POLYCARBONATE			WITH TEMP. GLASS TOP HALF		
ITEM	DESCRIPTION	PRICE	ITEM	DESCRIPTION	PRICE
14365	3' x 7'	\$665.00	14771	3' x 7'	\$720.00
14769	3' x 8'	\$695.00	14772	3' x 8'	\$755.00
12601	4' x 7'	\$695.00	13328	4' x 7'	\$755.00
14770	4' x 8'	\$755.00	14773	4' x 8'	\$839.00

**Includes:** Commercial Lever Latch, 1 Door Stop, 1 Bottom Sweep & Fasteners. **Outswing with hinges on left (outside)**



**Pictured:** 3' x 7' Double Hung (view from inside of the door)

Double Hung					
ALL POLYCARBONATE			WITH TEMP. GLASS TOP HALF		
ITEM	DESCRIPTION	PRICE	ITEM	DESCRIPTION	PRICE
14281	3' x 7'	\$1050.00	14282	3' x 7'	\$1095.00
14774	3' x 8'	\$1135.00	14776	3' x 8'	\$1195.00
14775	4' x 7'	\$1079.00	14777	4' x 7'	\$1265.00
13700	4' x 8'	\$1195.00	14778	4' x 8'	\$1375.00

**Includes:** Commercial Lever Latch, 2 Door Stops, 2 Bottom Sweeps, 1 Pull Chain, 1 Cane Bolt Fasteners and Center Astragal. **Main door is Outswing with hinges on left (outside)**

## BASIC ROLL-UP DOORS FOR HIGH TUNNELS

We can quote based on the size needed. Up to 9'x23' for our 30' structures. Maximum recommended height is 10 ft.

**Use:** 6.8 oz woven curtain poly, single wirelock across the top, 2 runs (center and bottom) of 1.6" galvanized pipe with roll-bar cap and a low wall gear crank. Or 1.315" galvanized pipe for doors at 11' or less in width.

**Pictured:** Basic roll-up door with swivel lock and hand crank and regular 6 mil plastic .



## DBCI CORRUGATED METAL ROLL-UP DOORS

26-gauge galvanized, polar white, grade E hard steel curtain with 5/8" ribbed corrugation. All models listed below are wind rated at 90 plus MPH. Unlike most other brands these doors have corrugated drum to prevent misalignment and for quieter operation. 9-1/2 to 12" drum diameter (depending on door size). For more info visit [www.dbci.com](http://www.dbci.com).

ITEM	DESCRIPTION	PRICE
15311	10' wide x 9' high, Series 690, 16 ga galv steel guides & windbar, no chain hoist	\$1400.00
4582	8' wide x 8' high, Series 650, 18-gauge galv steel guide system, no chain hoist	\$950.00





# GREENHOUSE SUPPLIES

## ALUMINUM SHUTTERS

These aluminum shutters from Hessaire are designed to be used as an inlet, but may also be used for free-air exhaust. Constructed of heavy gauge aluminum with galvanized steel reinforced corners.

ITEM	DESCRIPTION	PRICE
12709	16" Single Panel Shutter	\$54.95
4925	24" Single Panel Shutter	\$89.00
12976	30" Single Panel Shutter	\$110.00
12666	36" Double Panel Shutter	\$169.95
13330	40" Double Panel Shutter	\$195.00
11704	42" Double Panel Shutter	\$214.00
12298	48" Double Panel Shutter	\$232.00
13701	54" Double Panel Shutter	\$266.00
14780	60" Double Panel Shutter	\$324.00

For rough opening: add 1/2" to shutter size (both dimensions).



**Heavy Duty ACME Shutters Also Available in 36" and 48"**

## SHUTTER MOTOR KITS

Works with all the above shutters. 115/230V. Includes: motor, lever arm, chain, s-hooks, tension springs, mounting bracket and assembly hardware.

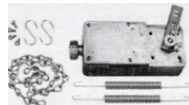

ITEM	DESCRIPTION	PRICE
10481	Shutter Motor Kit	\$109.00

## UNIVENT AUTOMATIC OPENER

Can be adjusted to open at between 60°- 70° F. Fully open at 86° F. Works on 30" & smaller "1 aluminum shutters. Lifts up to 33 lbs.



ITEM	DESCRIPTION	PRICE
10204	Univent Automatic Opener	\$48.95
12708	Hardware to mount to above shutters	\$2.95

## SHUTTER & SLANTWALL FANS

**JSF Shutter Fan** features heavy-duty combination motor mounted/safety guard with bright easy-to-clean zinc-chromate finish.

**JSW Slantwall Fan** features galvanized box and direct drive motors, except JSW36 and JSW50C are belt drive, wire mesh guard. JSW50C features a cone for better performance.

ITEM	SIZE	CFM	MOTOR	ROUGH OPENING	PRICE
11605	12"	970	1/10 hp/1,625	12-5/8"	\$210.00
11606	16"	1,440	1/10 hp/1,625	16-5/8"	\$220.00
4926	20"	3,140	1/3 hp/1,725	20-5/8"	\$295.00
11607	24"	4,640	1/2 hp/1,725	24-5/8"	\$360.00
11608	30"	6,770	1/2 hp/825	30-5/8"	\$442.00
11609	30"	7,100	1/2 hp/825	38"Hx37"W	\$759.00
11610	36"	9,700	1/2 hp belt drive/525	42"Hx41"W	\$1,375.00
11611	50"	21,600	1 hp belt drive/588	57"Hx55"W	\$1,450.00

## CIRCULATION FANS

With 10' cord, pre-wired for 115 volts, single phase. Totally enclosed, maintenance-free, direct drive high-efficiency motors have completely sealed ball bearings. JHF20 only: motors are variable speed capable (controller not included).

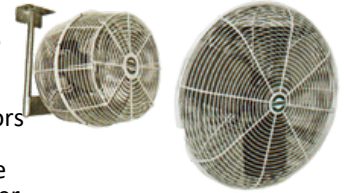

ITEM	DESCRIPTION	PRICE
11543	20" EZ-Breeze Fan, 1,680 CFM 1/10 hp, 1.08 amps	\$162.95
<b>11783 &amp; 4805 Front can be opened for cleaning.</b>		
11783	12" Green Breeze Fan, 970 CFM 1/10 hp, 1.12 amps	\$174.00
4805	20" Green Breeze Fan, 3,650 CFM 1/3 hp, 3.52 amps	\$280.00

## CIRCULATION FAN

This 12" Hessaire circulation fan features industrial grade aluminum blades. Guards are powder coated. Bracket included. Single phase, 115V, 1.0A, 1/10 hp motor. 1,085 CFM

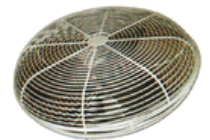

ITEM	DESCRIPTION	PRICE
11544	12" Fan	\$113.00

## EUROEMME HEAVY-DUTY EXHAUST FANS

Centrifugal shutter system keeps the efficiency of the fan at peak all the time by keeping the shutters fully open. Shutters do not have to be cleaned regularly. Heavy duty galvanized shutters are tightly closed when the fan is not in operation, preventing any air leakage. Considering the effect of dirty shutters on the other slant wall fans, the efficiency of the Euroemme fan is 15-25% better than any other fan.



ITEM	DESCRIPTION	CFM @ 0" STATIC PRES.	MOTOR	ROUGH OPENING	PRICE
11545	36"	11,650	3/4 hp	43"	\$1,295.45
11546	50"	20,500	1 hp	54½"	\$1,495.00

A complete ventilation system is essential for all greenhouse applications.

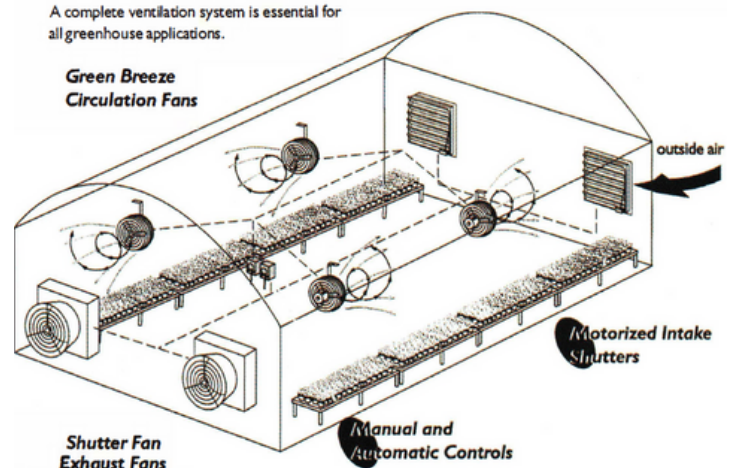

# GREENHOUSE SUPPLIES

## MODINE MODEL PTP

Stainless Steel Heat Exchangers for longer life. 82% Efficiency. Modine's horizontal power vented PTP unit heater line—electronic ignition with 100% shutoff and continuous retry. The power vent does not require vertical vent pipe.



ITEM	BTU/HR INPUT/OUTPUT	CFM	VENT SIZE	WEIGHT	PRICE
11560	150,000/123,000	2,140	4"	165 Lbs	\$1,700.00
11561	175,000/143,500	2,725	4"	210 Lbs	\$1,880.00
4906	200,000/164,000	2,870	4"	220 Lbs	\$1,990.00
14781	250,000/205,000	3,995	6"	265 Lbs	\$2,380.00
14153	300,000/246,000	4,545	6"	270 Lbs	\$2,700.00
13352	350,000/290,000	5,280	6"	320 LBS	CALL

## MODINE MODEL PDP

83% Efficiency. Modine's vertical power vented PDP unit heater line. Electronic ignition with 100% shutoff and continuous retry. Power vent does not require vertical vent pipe.



ITEM	BTU/HR INPUT/OUTPUT	CFM	VENT SIZE	WEIGHT	PRICE
11562	150,000/124,500	2,180	5"	168 Lbs	\$1,550.00
10328	175,000/145,250	2,550	5"	175 Lbs	\$1,660.00
11564	200,000/166,000	2,870	5"	239 Lbs	\$1,750.00
11563	250,000/207,500	3,700	6"	239 Lbs	\$2,200.00
15552	300,000/249,000	4,460	6"	295 LBS	CALL

## MODINE EFFINITY93

Modine Model PTC. With Stainless Steel Heat Exchangers for longer life. At 93% efficiency, Modine's Effinity93 is the most efficient condensing unit heater in North America. Direct Spark Ignition. Power Exhaust. High Efficiency Separated Combustion. Use a PVC vent pipe, the same size pipe as the combustion air inlet. (Do not draw combustion air out of the greenhouse.) Drains an acidic condensate. The vent and drain must be installed properly.



ITEM	BTU/HR INPUT/OUTPUT	CFM	VENT SIZE	WEIGHT	PRICE
13575	85,000/79,050	1,650	3"	125 Lbs	\$2,695.00
14782	135,000/125,550	2,160	3"	165 Lbs	\$4,280.00
14783	180,000/167,400	3,020	4"	215 Lbs	\$4,500.00
14784	215,000/199,950	3,865	4"	265 Lbs	\$4,990.00
13329	260,000/241,800	4,585	4"	265 Lbs	\$5,800.00

## MODINE HOT DAWG®

Electronic Ignition with 100% shutoff and continuous retry. Power vent does not require a vertical vent. 82% Efficiency.

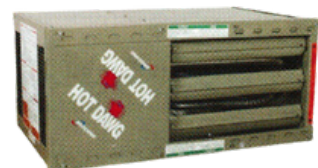

ITEM	BTU/HR INPUT/OUTPUT	CFM	VENT SIZE	WEIGHT	PRICE
13390	45,000/36,900	720	3"	60 Lbs	\$882.00
12667	75,000/61,500	1,160	3"	85 Lbs	\$1,000.00
14170	100,000/82,000	1,490	4"	125 Lbs	\$1,180.00
13025	125,000/102,500	1,980	4"	128 Lbs	\$1,290.00



# GREENHOUSE SUPPLIES

## PLASTIC BENCH TOPS FROM A-V INTERNATIONAL

- Polypropylene, UV protected
- Durable and lightweight, no sagging
- Can withstand extremely cold and hot temperatures
- Installs on any type of frame with screws or pop rivets
- Frame every 2 feet for flats, or pots less than 3 gallon.
- Easy interlocking assembly
- Flats, plug trays, and pots slide easily over the surface
- Easy to clean and disinfect
- Will not rust or decay
- Inorganic, prevents the growth of mold and fungus
- No protruding wires or jagged metal edges
- Easy, positive interlocking feature on 48" sides, no clips required



ITEM	DESCRIPTION	1-77	78+
12913	24" X 48" Plastic Bench Tops	\$17.55	\$16.50
ITEM	DESCRIPTION	1-175	176+
12918	18" x 36" Plastic Bench Tops	\$11.95	\$11.25

## GREENHOUSE BENCHES

We have partnered with Nolt's Greenhouse Supply to offer you a complete top notch heavy duty greenhouse bench OR use their components to create your own.

A heavy-duty galvanized square tubing frame with reinforced smooth corners, SS fasteners, and A-V plastic bench tops (above) makes this bench exceptionally durable. Plastic bench tops prevent the growth of mold and fungus. For shipping/transport purposes, we sell benches without legs. Use the leg kits below, or for easy-to-stow benches use cement blocks.



13429  
4' x 8'  
Bench Top

ITEM	DESCRIPTION	1-9	10+
13429	4' x 8' Bench Top	\$166.00	\$163.00
13830	4' x 10' Bench Top	\$195.00	\$185.00
12742	4' x 12' Bench Top	\$225.00	\$216.50
15773	4' x 14' Bench Top	\$256.75	\$247.00

LEG KITS INCLUDE: 4 LEGS AND ALL HARDWARE TO INSTALL AND BRACE

15600	24" Leg Kit	\$82.00	\$77.00
14171	30" Leg Kit	\$84.00	\$79.00
13430	36" Leg Kit	\$87.00	\$82.00

## BENCH COMPONENTS

Build your own heavy-duty benches using these parts and plastic bench tops or galvanized wire mesh.



15800 (installed)

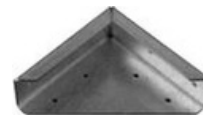

15800 (bottom view)



15802



15801

ITEM	DESCRIPTION	PRICE
13935	Galvanized Square Tubing, 1.5" x 24", 16 gauge	\$40.00
11584	Metal End Wall Angle to fasten center support	\$0.59
15800	Galvanized Corner Bracket, designed to add strength and smoothen the corner	\$4.70
15801	Tek Screw SS Pan Head #12 x 1", to fasten corner and angle brackets	\$17.95 100/BAG
15802	Tek Screw SS Flat Head #14 x 1-1/2", to fasten plastic bench tops	\$17.95 50/PACK
15803	Aluminum Brace, 1 x 12", use 2 per leg	\$2.75

## GALVANIZED WIRE MESH

This heavy-duty, 12.5 gauge, 1" x 2" rectangles, galvanized wire mesh is great for greenhouse bench tops.

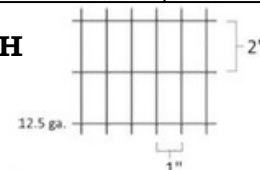

ITEM	DESCRIPTION	PRICE
14915	Galvanized Wire Mesh 4' x 100'	\$560.00
14916	Galvanized Wire Mesh 6' x 100'	\$795.00

# GREENHOUSE SUPPLIES

## THERMALARM II

Metal contacts close this normally open switch when temperatures exceed the limits you set. Temperature range: 20°-110° F. No magnetic switch, no relay needed. 6-12 volts.



ITEM	DESCRIPTION	PRICE
14787	Thermalarm II	\$53.50

## THERMOSTATS

These corrosive environment thermostats can be wired for heating or cooling. Up to 240Vac. SS sensor. Temperature range: 40°-100° F.

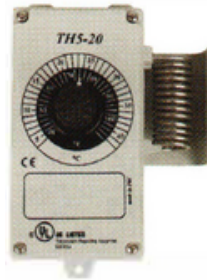

ITEM	DESCRIPTION	PRICE
4774	Single Stage Thermostat	\$36.00
13931	2 Stage Peco Thermostat, can be wired for 2 speed	\$100.00
11566	Waterproof Cord Connector	\$6.80

## K-KONTROLS THERMOSTAT

A Line Voltage Thermostat works great for direct control of heaters, fans, air conditioners, ventilation equipment and more. Great for both heating and cooling applications.



ITEM	DESCRIPTION	MFG CODE	PRICE
15391	K-Kontrol Single Stage Thermostat	KJ16110	\$85.00
15392	K-Kontrol Two Stage Thermostat	KT16110	\$110.45

## SENSAPHONE®

Remote Monitoring. Protect your investment even when you can't be there. Monitors your unattended facility to detect power failures, temperature extremes, intrusions, water incursion, sounds such as smoke and burglar alarms, and other conditions of your choice.



Includes built-in sensors to monitor a variety of conditions: High sound level; AC electric power failure; Battery backup; Temperature (uses 1 input). Configurable inputs work with temperature sensors and normally open & normally closed switch type sensors

ITEM	DESCRIPTION	PRICE
15789	Sensaphone 400 - 4 configurable inputs, dials up to 4 phone numbers	\$479.95
15790	Sensaphone 800 - 8 configurable inputs, dials up to 8 phone numbers	\$690.00

## SIRENS



14079



14080



14081

ITEM	DESCRIPTION	PRICE
14079	Outdoor Siren, Dual Tone, 115 dB, 6-12 VDC	\$29.50
14080	Indoor Siren, Dual Tone, 110 dB, 6-12 VDC	\$20.75
14081	12V Lantern Battery, thumb screw terminals	\$21.75

## PREWIRED TEMPERATURE ALERT

Low and high temperature alert. This sensor, made from a pair of our single stage mechanical thermostats, features superior accuracy and reliability, and will be less likely to corrode or stick than a Thermalarm. Set your desired temperature limits between 40° and 110° F. Labeled, easy to test, no relay needed, wired for up to 24 volts. Prewired with 6' wire to battery and 60' to siren. Battery and siren not included.



ITEM	DESCRIPTION	PRICE
14150	Prewired Temperature Alert	\$110.00

## CONVECTION TUBING

Kenbar convection tubing is made from clear polyethylene and is protected with a strong ultraviolet inhibitor. The plastic is formulated for maximum light penetration and for durability in a greenhouse environment.



### Convection Tubing Punch Position

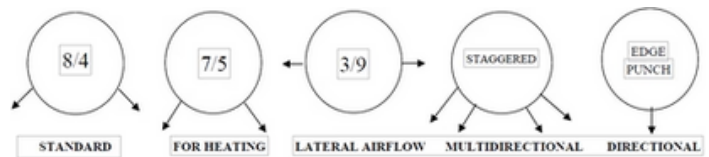

We will ship standard 8/4 punch unless otherwise specified. For staggered or edge punch add \$0.12/ft.

ITEM	DESCRIPTION	PRICE/FT
14785	12" Dia. Tubing, 6 mil 3 year	\$1.00/FT
12786	18" Dia. Tubing, 6 mil 3 year	\$1.20/FT
3807	20" Dia. Tubing, 6 mil 3 year	\$1.25/FT
12038	24" Dia. Tubing, 6 mil 3 year	\$1.55/FT
14786	30" Dia. Tubing, 6 mil 3 year	\$1.85/FT
4 mil is also Available, Call for Pricing		

**DISPLAY RACKS, TRANSPORT CARTS, NURSERY CARTS, AND GREENHOUSE SHOPPING CARTS**  
**ALL TYPES OF CARTS AND RACKS TO HELP STREAMLINE YOUR GREENHOUSE.**  
**CALL FOR MORE DETAILS.**



# GREENHOUSE SUPPLIES

## GREENHOUSE FRAMES

Manufactured in Dundee OH, all the greenhouse and high tunnel frames on this page and page 47 feature triple galvanized tubing for years of service. Call for pricing on any length frames, custom arch spacing, higher side walls and crosssties, or rack & pinion roof vent. See page 48 or contact us for a detailed quote on a complete greenhouse or high tunnel package customized to your needs. Prices subject to change without notice. Call to request a quote or check availability.

### 12' & 16' QUONSET GREENHOUSES FRAME

Ground Stakes – 1.66" x 72"

Bows – 1.315"

Purlins – 1.315"

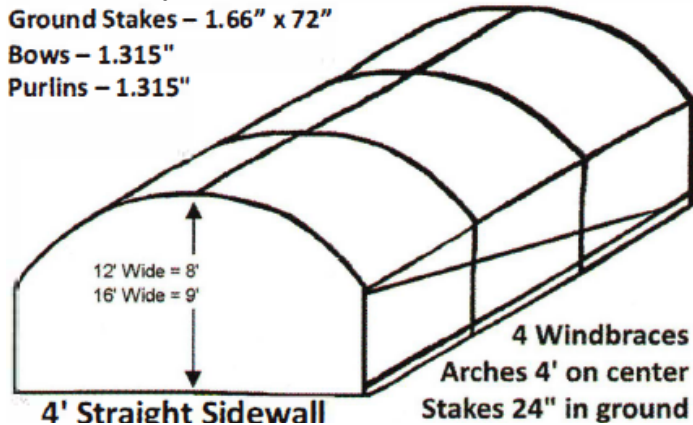

Both 12' & 16' have 3 purlins and 4 wind braces. Includes pipe straps for fastening purlins, pipe straps and bolts for baseboard, end wall brackets assembly instructions and stake driver.

### 12' QUONSET GREENHOUSE FRAME

12' uses 24' wide plastic cover

ITEM	LENGTH	12' WIDE
15618	24'	\$950.00
15751	48'	\$1,625.00
15752	72'	\$2,489.00
15753	96'	\$3,135.00

### 16' QUONSET GREENHOUSE FRAME

16' uses 28' wide plastic cover

ITEM	LENGTH	16' WIDE
15808	24'	\$1,229.00
13056	48'	\$2,200.00
15809	72'	\$2,775.00
15810	96'	\$3,695.00

## INDIVIDUAL FRAME COMPONENTS

ITEM	DESCRIPTION	PRICE
11531	12' wide, 1 piece Bow, 1.315" 16 ga	\$55.00
11532	16' wide, 1 piece Bow, 1.315" 14 ga	\$75.00
11533	20' wide, 1 piece Bow, 1.315" 14 ga	\$87.75
11534	21' wide, 1 piece Bow, 1.66" 14 ga	\$110.00
11535	72" Ground Stake, 1.66" 13 ga	\$20.00
11536	78" Ground Stake, 1.90" 13 ga	\$24.95
11537	96" Ground Stake, 1.90" 13 ga	\$27.95
11538	Ground Stake Driving Head, for 1.66"	\$12.00
11539	Large Ground Stake Driving Head, for 1.9"	\$16.00
10320	30' Arch Halves 1.66" 14 ga	\$62.50

Extended Lead Times. Prices subject to change without notice.

### 21' PEAKED HIGH TUNNEL, 5' STRAIGHT SIDES FRAME

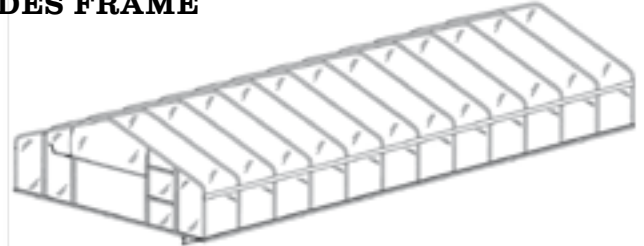

This 21' frame is 10 1/2' to peak and has 3 purlins and 4 wind braces. Hardware includes cross connectors and pipe straps for fastening purlins, pipe straps and bolts for baseboard, end wall brackets assembly instructions, and stake driver. Uses 35' wide plastic cover. Optional Crossties 1.315" x 14ga w/1 upright brace.

ITEM	SIZE	PRICE	OPTIONAL 7' CROSSTIES
15312	21' X 24'	\$1,495.00	ADD: \$208.00
15222	21' X 48'	\$2,795.00	ADD: \$458.00
15811	21' X 72'	\$3,685.00	ADD: \$702.00
14865	21' X 96'	\$4,595.00	ADD: \$446.00

### 24' GOTHIC GREENHOUSE, 4' STRAIGHT SIDES FRAME

Arches 1.660" x 14 ga  
Stakes 1.900" x 13 ga  
Crosstie 1.315" x 14 ga  
Braces 1.315" x 16 ga  
Purlins 1.315" x 17 ga

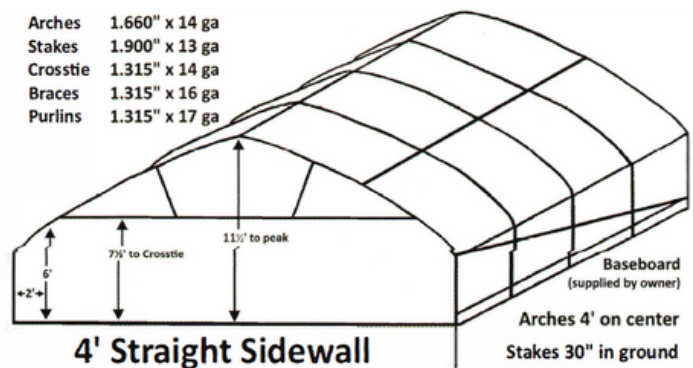

ITEM	SIZE	PRICE	OPTIONAL 5 1/2' SIDEWALL
13530	24' X 48'	\$3,859.00	ADD: \$81.00
15649	24' X 72'	\$4,695.00	ADD: \$119.00
15816	24' X 96'	\$5,795.00	ADD: \$156.00

# GREENHOUSE SUPPLIES

## 30' STANDARD GOTHIC GREENHOUSE FRAME ONLY

- Arches 1.660" x 14 ga
- Stakes 1.900" x 13 ga
- Crosstie 1.315" x 14 ga
- Braces 1.315" x 16 ga
- Purlins 1.315" x 17 ga

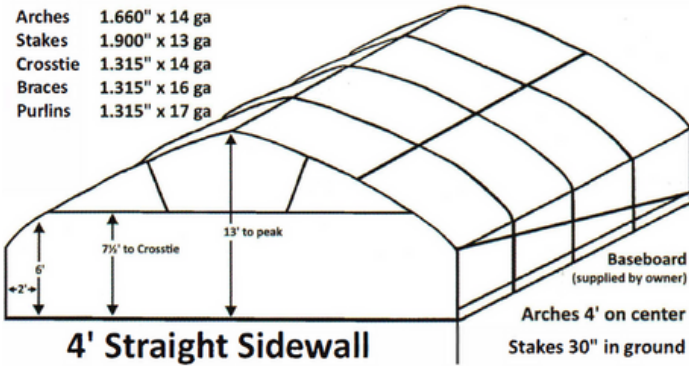

This 30' frame has crosstie assembly on each arch except end arches, 5 purlins and 4 wind braces. Hardware includes: heavy duty cross connectors and pipe straps for fastening purlins, pipe straps for baseboard, end wall brackets, assembly instructions and stake driver. Uses 46' wide plastic cover.

SIZE	ITEM	PRICE	OPTIONAL 5 1/2' SIDEWALL
30' X 48'	13620	\$3,985.00	ADD: \$81.00
30' X 72'	15553	\$5,500.00	ADD: \$119.00
30' X 96'	15822	\$8,695.00	ADD: \$156.00
30 X 144'	15818	\$9,985.00	ADD: \$231.00

## 30' NORTHERN GOTHIC GREENHOUSE FRAME ONLY

This 30' frame has the same specifications as the one to the left except: 1.9" 13 gauge arches with 6" long swedge to insert into the ground stake. This makes it stronger and capable of carrying more snow load. Recommended for heavy snowfall areas.

SIZE	ITEM	PRICE	OPTIONAL 5 1/2' SIDEWALL	OPTIONAL W BRACING FOR CROSSTIES
30' X 48'	15828	\$5,595.00	ADD: \$81.00	ADD: \$348.00
30' X 72'	15829	\$6,595.00	ADD: \$119.00	ADD: \$520.00
30' X 96'	13914	\$8,500.00	ADD: \$156.00	ADD: \$686.00
30 X 144'	15827	\$11,995.00	ADD: \$231.00	ADD: \$1,035.00

## 34' NORTHERN GOTHIC GREENHOUSE FRAME ONLY

This 34' frame has same specifications as the 30' to the left except: 7 purlins & 1.9" 13 gauge arches with 6" long swedge to insert into ground stake. It also comes standard with W bracing on the crossties (4 braces per crosstie). Uses 50' wide plastic

SIZE	ITEM	PRICE	OPTIONAL 5 1/2' SIDEWALL
34' X 48'	15824	\$5,500.00	ADD: \$81.00
34' X 72'	15825	\$7,850.00	ADD: \$119.00
34' X 96'	15826	\$10,500.00	ADD: \$156.00
34' X 144'	15823	\$14,885.00	ADD: \$231.00

## GREENHOUSE HIGH TUNNEL

This high tunnel package comes with two layers of plastic, an inflation blower, plastic for end walls, and two roll-up sides. It also includes all hardware and parts required for assembly, with a detailed construction manual. Additional add-ons are available, such as heaters, fans, and temperature alarms. Contact for a quote on different sizes.

**21' X 48" 12636**

QTY	UNIT	DESCRIPTION
1	ea	21x48' Peaked Greenhouse frame
1	ea	36x110' 6 Mil 4 year Tufflite IV Plastic
1	ea	14x100' 6 Mil 4 year Tufflite IV Plastic
1	ea	3/4"x500 Batten Tape
1	ea	3 Bolt Blower KIT 60 CFM w/cord115V
1	ea	3 Bolt Blower Mounting Kit
9	Pcs	8' Single WireLock Base
8	Pcs	12' DOUBLE WireLock Base
2	100 Pcs	1" #12 SS Self Drilling TEK Screw
2	50/Bun ea	4' ZigZag Wire
2	ea	GC5:1B 5:1 GearCrank w/1.315 adapter
2	ea	6' Guide Pipe Asy, for 5:1 Gearcrank
12	ea	Aluminum Rope Hooks
14	ea	4" Zinc Plated Eye Screw 5/16"
1	350' Roll	1/4" Rope NeoBraid Black 100% polyester
50	ea	1" Fabric Clip, Fits 1-1/8" OD Pipe
8	ea	1-3/8" 17ga 147" Swedged Purlin Pipe
1	ea	Roll-pipe Hanger for 2" Baseboard, 9/ PK

**30' X 72" 12469**

QTY	UNIT	DESCRIPTION
1	ea	30x72' Gothic Greenhouse Frame
1	ea	48x150' 6 Mill 4 Year Tufflite IV Plastic
1	ea	14x100' 6 Mill 4-Year Tufflite IV Plastic
1	ea	3/4"x500 Batten Tape
1	ea	4 Bolt Blower KIT 148 CFM w/Cord 115V
1	ea	4 Bolt Blower Mounting Kit
8	Pcs	12' Single WireLock Base
12	Pcs	12' DOUBLE WireLock Base
2	100 Pcs	1" #12 SS Self Drilling TEK Screw
3	ea	4' ZigZag Wire
2	ea	GC5:1B 5:1 GearCrank w/1.315 adapter
2	ea	6' Guide Pipe Asy, for 5:1 Gearcrank
1	25/Pk	Aluminum Rope Hooks
20	ea	4" Zinc Plated Eye Screw 5/16"
1	350' Roll	1/4" Rope NeoBraid Black 100% polyester
74	ea	1" Fabric Clip, Fit 1-3/8" OD Pipe
12	ea	1-3/8" 17 ga 147" Swedged Purlin Pipe
1	ea	Roll-pipe Hanger for 2" Baseboard, 9/PK



# GREENHOUSE SUPPLIES

**21' X 72' 12468**

QTY	UNIT	DESCRIPTION
1	ea	21x48' Peaked Greenhouse frame
1	ea	36x150' 6 Mil 4 year Tufflite IV Plastic
1	ea	14x100' 6 Mil 4 year Tufflite IV Plastic
1	ea	3/4"x500 Batten Tape
1	ea	4 Bolt Blower KIT 148 CFM w/cord115V
1	ea	4 Bolt Blower Mounting Kit
9	Pcs	8' Single WireLock Base
12	Pcs	12' DOUBLE WireLock Base
2	100 Pcs	1" #12 SS Self Drilling TEK Screw
2	50/Bund	4' ZigZag Wire
2	ea	GC5:1B 5:1 GearCrank w/1.315 adapter
2	ea	6' Guide Pipe Assy, for 5:1 Gearcrank
1	25/Pk	Aluminum Rope Hooks
20	ea	4" Zinc Plated Eye Screw 5/16"
1	350' Roll	1/4" Rope NeoBraid Black 100% polyester
74	ea	1" Fabric Clip, Fits 1-3/8" OD Pipe
12	ea	1-3/8" 17ga 147" Swedged Purlin Pipe
1	ea	Roll-pipe Hanger for 2" Baseboard, 9/ PK

**21' X 96' 14714**

QTY	UNIT	DESCRIPTION
1	ea	21x96' Peaked Greenhouse frame
1	ea	36x100' 6 Mil 4 year Tufflite IV Plastic
1	ea	36x100' 6 Mil 4 year Tufflite Infrared Plastic
1	ea	14x100' 6 Mil 4 year Tufflite IV Plastic
1	ea	3/4"x500 Batten Tape
1	ea	4 Bolt Blower KIT 148 CFM w/cord115V
1	ea	4 Bolt Blower Mounting Kit
9	Pcs	8' Single WireLock Base
16	Pcs	12' DOUBLE WireLock Base
3	100 Pcs	1" #12 SS Self Drilling TEK Screw
3	50/BUND	4' ZigZag Wire
2	ea	GC5:1B 5:1 GearCrank w/1.315 adapter
2	ea	6' Guide Pipe Assy, for 5:1 Gearcrank
1	25/Pk	Aluminum Rope Hooks
26	ea	4" Zinc Plated Eye Screw 5/16"
1	350' Roll	1/4" Rope NeoBraid Black 100% polyester
100	ea	1" Fabric Clip, Fits 1-3/8" OD Pipe
16	ea	1-3/8" 17ga 147" Swedged Purlin Pipe
1	ea	Roll-pipe Hanger for 2" Baseboard, 9/ PK

**30' X 96' 14864**

QTY	UNIT	DESCRIPTION
1	ea	30x96' Gothic Greenhouse Frame
1	ea	48x100' 6 Mill 4 Year Tufflite IV Plastic
1	ea	48x100' 6 Mill 4 Year Tufflite Infrared Plastic
1	ea	14x100' 6 Mill 4 Year Tufflite IV Plastic 3/4"x500
1	ea	Batten Tape
1	ea	4 Bolt Blower KIT 148 CFM w/Cord 115V
1	ea	4 Bolt Blower Mounting Kit
8	Pcs	12' Single WireLock Base
16	Pcs	12' DOUBLE WireLock Base
3	100 Pcs	1" #12 SS Self Drilling TEK Screw
3	50/BUND	4' ZigZag Wire
2	ea	5:1 GearCrank w/1.315 adapter
2	ea	6' Guide Pipe Assy, for 5:1 Gearcrank
1	25/Pk	Aluminum Rope Hooks
26	ea	4" Zinc Plated Eye Screw 5/16"
1	350'Roll	1/4" Rope NeoBraid Black 100% polyester
100	ea	1" Fabric Clip, Fit 1-3/8" OD Pipe
16	ea	1-3/8" 17 ga 147" Swedged Purlin Pipe
1	ea	Roll-pipe Hanger for 2" Baseboard, 9/PK

## 21' PEAKED HIGH TUNNELS

- 10½' to peak, 5' Straight Sidewall.
- Arches: 1.66" x 14 gauge, Stakes: 1.9" x 13 gauge.
- Purlins & wind braces: 1.315" x 17 gauge
- Crossties are optional.

## 30' GOTHIC GREENHOUSE (OR TUNNEL) FRAME

Arches: 1.660" x 14 ga  
 Stakes: 1.900" x 13 ga  
 Crosstie: 1.315" x 14 ga  
 Braces: 1.315" x 16 ga  
 Purlins: 1.315" x 16 ga

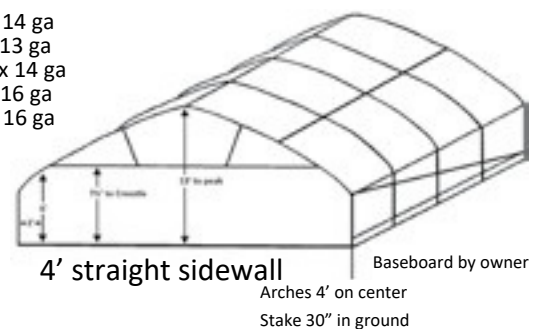

**FREIGHT IS ADDITIONAL.  
 ALL PRICES ARE FOB LEOLA, PA**

# GREENHOUSE SUPPLIES

## MANUAL GEAR CRANK OPERATOR PACKAGES

5:1 Ratio, internal brake. Needs to be reached from the ground. Uses 1" OD guide pipe. Rolls up to 96'.

**Not for use with Roll Lock (use HD cranks).**



ITEM	DESCRIPTION	PRICE
10190	5:1 Gear Crank, fits 1.315" roll pipe	\$89.55
10191	6' Guidepipe & Hanging Hrdware for 10190	\$17.95

**7:1 Ratio**, Heavy-duty, internal brake. Includes 24" crank handle. Rolls up to 120', works with Roll-Lock. Fits 1.315" guidepipe and roll pipe.



4772

**13:1 Ratio**, Heavy-duty, internal brake. Includes 24" crank handle. Rolls up to 240', works with Roll-Lock. Fits 1.315" guidepipe and roll pipe.



11547

11551

ITEM	DESCRIPTION	PRICE
4772	7:1 Gear Crank with 24" crank handle	\$149.00
11547	13:1 Gear Crank with 24" crank handle	\$190.00
11548	14" Drill Crank (For 4772 & 11547)	\$26.95
11550	120" Crank handle (For 4772 & 11547)	\$56.95
11551	Loop handle (For 4772 & 11547)	\$42.95

## STEEL SWIVEL LOCK & HAND CRANK

Simple roll up crank. Includes locking universal joint and hand crank. Use 1.315" pipe to connect the pieces (not included). Pipe should be long enough so that handle locks against the ground. Only recommended for rollup sides or doors are 36' or shorter.

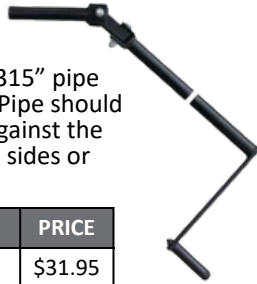

ITEM	DESCRIPTION	PRICE
10724	Hand Crank & Swivel Lock	\$31.95

## MANUAL GEAR CRANK FOR DOORS

Doesn't require a guide pipe and allows the roll pipe to touch the ground. Ideal for doors or curtains that don't reach to the end of the structure. Stays attached to the roll pipe and is held at the correct height by securing handle to sidewall. 7:1 ratio with internal brake. Fits 1.315" roll pipe. 1.66" adapters also available.

ITEM	DESCRIPTION	PRICE
13370	7:1 Gear Crank with 4' long handle	\$233.00



## LOW VOLTAGE CONTROLLERS

For ventilation control on roll-up sides and roof vents with low voltage motor packages.

110VAC input, 24VDC output. Also controls heaters and fans. All controllers have a manual override.

For custom touch-screen controllers to control all ventilation and heat in your greenhouses call with your requirements for a quote.



11552

11553

ITEM	DESCRIPTION	PRICE
11552	Controller; 1 stage of rollups (1 or 2 motors) + 2 stages dry contacts for heaters, fans, etc.	\$865.25
11553	AegisTEC Touchscreen Controller; 2 stages of rollups (3 motors) + 2 stages contacts for heaters, fans, etc. With timed, weather & humidity override options. Sensors sold separately.	\$1095.00
13442	AegisTEC-Plus Touchscreen Controller; Same as above except more capacity. Dual zone capable (2nd sensor needed).	\$1750.00
12603	Manual Transformer	\$647.55
11556	Contractor to run fans, max 25 amps	\$135.00
14745	Humidity Sensor, override for all above	\$529.00
14746	Rain Sensor, override for AegisTEC	\$360.00
14747	Anemometer, Wind override for AegisTEC	\$259.50

Also available: Solar powered controllers and interface boxes to accept signals from other controllers.

## LOW VOLTAGE MOTOR OPERATOR PACKAGES

Energy efficient yet powerful! 24VDC motors. Rolls up to 6 x 200 curtain. Includes roller guide, adapter for 1.315" roll pipe and guidepipe hardware. Use 1.315" guidepipe.

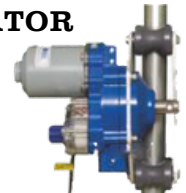

ITEM	DESCRIPTION	PRICE
11558	60NM, rolls up to 5' x 200' curtain - Left	\$350.00
11558R	60NM, rolls up to 5' x 200' curtain - Right	\$339.00
11559	Limit Switch required if using with Roll-Lock	\$106.50

## SOLARSIDE® WOVEN CURTAIN POLY

Great for rollup curtains, rollup doors or gable end covering.

- More durable and puncture resistant than 6mil poly.
- Lightweight and extremely strong
- Diffuses light evenly
- UV Stabilized
- 87% Light transmission
- 6.8 oz/sq. yd.



ITEM	DESCRIPTION	1'-99'	100'-199'	200+
12686	6' Solarside Reinforced Poly	\$1.95	\$1.85	\$1.75
12693	13' Solarside Reinforced Poly	\$3.69	\$3.50	\$3.40



# GREENHOUSE SUPPLIES

## AGRITAPE HEAT MAT SYSTEM

The Agritape system includes a control unit, Agritape Heat Mat, and grounding screen that regulates soil temperature and safely grounds the current if the tape is damaged. The system doesn't work with GFCI outlets and uses black bars to create a continuous heat pattern. To install, place the mat and cover it with the ground screen, connect the ground wire from the control unit to the screen, and put the sensor in the soil of the seed tray or container. The Agritape can increase soil temperature up to 20°F above room temperature.

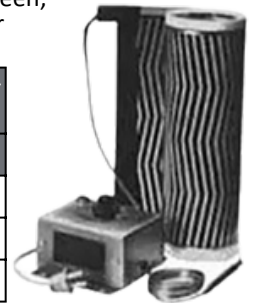

**Control Units:** Multi-outlet power strips can be used to add mats to a controller, however, DO NOT exceed amp rating or max amp of tape.

ITEM	DESCRIPTION	PRICE
11150	Digital Control, 1 outlet, digital thermostat. Max: 50 sq. ft. of heat mats. Rated 8.5 amps.	\$78.95
4330	AT-JR Control, 2 outlets, Dial Thermostat	\$147.95
10454	Agritape Dial Thermostat 4 Outlets	\$164.95

## HEAT MATS

**Non Stock:** Shipping charge may incur.

ITEM	DESCRIPTION	PRICE
10452	11" Agritape - Custom Length (1-9 ft.)	\$9.75/ft.
11151	11" Agritape - Custom Length (10-25 ft.)	\$8.85/ft.
10453	Grounding Screen (for custom mats) 1-6 ft. wide, any length.	\$1.30/per sq. Ft.

## NURSERY CART

Wheelbarrow style with stops to prevent it from tipping forward. Quality green paint. Two 13" flat free tires.

**Bed Dimensions:** 60" length x 28" width x 19" height



ITEM	DESCRIPTION	PRICE
12488	Two-wheeled Nursery Cart	\$440.00

## GREENHOUSE SHOPPING CARTS

This handy greenhouse cart features handles on both ends. Painted green, 10" flat-free tires, 2 swivel and 2 rigid.

**Dimensions:**

- **Double Deck Cart:**
  - 40" length x 21" width x 34" height
- **Triple Deck Cart:**
  - 48" length x 21" width x 43" height



ITEM	DESCRIPTION	PRICE
10687	Double Deck Shopping Cart	\$440.00
12489	Triple Deck Shopping Cart	\$565.00

## PLANT TRANSPORT CART

- All metal construction
- Green powder coat paint
- 56-1/2" long x 21" wide x 82-1/2" high - Item#10685
- 56-1/2" long x 21" wide x 84-3/4" high - Item#14088
- Cart has tow hitch and coupling
- Shelves are 2" x ' wire grid
- Each shelf holds 5 true 1020 trays or 4 standard 1020 trays, and other common pot trays
- Price includes the base and 4 removable shelves

ITEM	DESCRIPTION	PRICE
10685	Plant Transport Cart with 4 shelves 6 x 2: casters (rubber over cast iron)	\$448.00
14088	Plant Transport Cart with 4 shelves 8" Foam Filled Pneumatic Wheels	\$580.00
10686	Additional Shelves for Transport Cart	\$36.00

## HEAT MATS

ITEM	DESCRIPTION	PRICE
4668	11" x 4" Agritape Heat Mat	\$45.75
4327	11" x 10' Agritape Heat Mat	\$82.95
10776	11" x 8" Agritape Heat Mat	\$92.50
4328	22" x 10' Agritape Heat Mat	\$139.95
11155	44" x 8' Agritape Heat Mat	\$193.45
11152	22" x 4" Agritape Heat Mat	\$78.95
11153	22" x 8" Agritape Heat Mat	\$113.95

## HANGING BASKET DISPLAY RACK

Holds approximately 25 baskets.

Constructed from 14 gauge Gatorshield Galvanized square tubing. It has 2 solid casters on one end and 2 swivel casters on the other end. Collapsible.

**Dimensions:** 7' high x 8' long x 4' wide at the base



ITEM	DESCRIPTION	PRICE
14003	Display Rack, 5" solid rubber casters with brakes	\$350.00
4775	Display Rack, 10" flat free tires - NO brakes	\$485.00

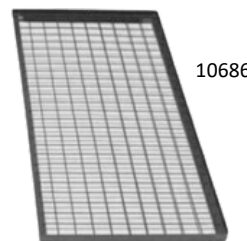

10686



10685

# POTS & TRAYS

## L SERIES PACKS (INSERTS) STANDARD 1020 SIZE

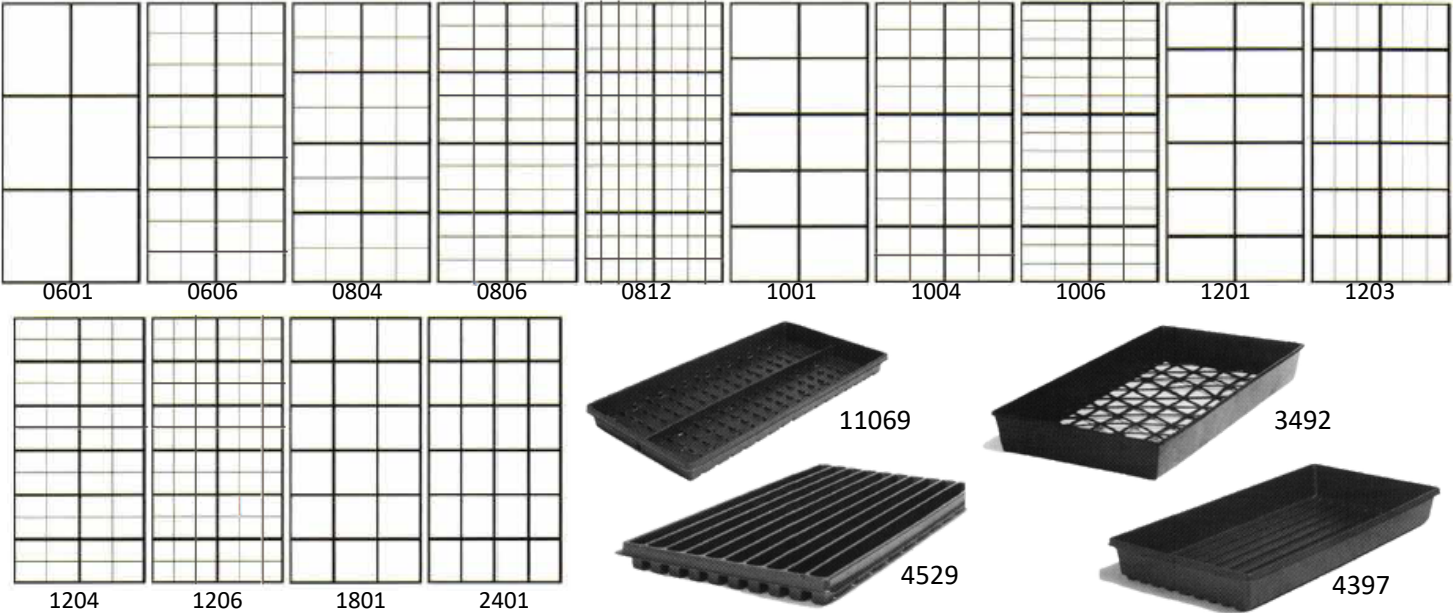

L SERIES PACKS STANDARD 1020 SIZE 20.85" X 10.42" PERFORATED AND EASY TO TEAR					MFG CODE	CELL DIMENSIONS			PACK VOLUME	
ITEM	DESCRIPTION	SHEETS/CASE	1-5 CS	6+ CS		LENGTH	WIDTH	DEPTH	LIQUID	CU. IN.
3452	601, 6 packs of 1 cell	100	\$62.50	\$61.00	STI-601	6.44	4.85	2.33	1.13 qt	65.05
4207	606, 6 packs of 6 cells	100	\$58.50	\$56.50	STI-606	2.35	2.15	2.33	1.91 pt	55.10
3494	804, 8 packs of 4 cells	100	\$59.00	\$58.00	STI-804	2.35	2.35	2.33	1.48 pt	42.72
3495	806, 8 packs of 6 cells	100	\$59.50	\$58.00	STI-806	2.35	1.55	2.33	1.34 pt	38.81
10321	812, 8 packs of 12 cells	100	\$59.50	\$57.50	STI-812	1.52	1.13	2.33	-	-
11059	1001, 10 packs of 1 cell	100	\$62.50	\$61.00	STI-1001	4.80	3.85	2.33	-	-
11061	1004, 10 packs of 4 cells	100	\$59.50	\$58.00	STI-1004	2.40	1.85	2.33	1.09 pt	31.44
11062	1006, 10 packs of 6 cells	100	\$64.50	\$63.00	L1006	1.85	1.75	2.33	0.99 pt	28.63
11063	1201, 12 packs of 1 cell	100	\$62.50	\$61.00	STI-1201	4.85	3.15	2.33	1.01 pt	29.29
11064	1203, 12 packs of 3 cells	100	\$62.50	\$61.00	STI-1203	3.15	1.55	2.33	0.89 pt	25.81
10641	1204, 12 packs of 4 cells	100	\$55.50	\$54.00	STI-1204	2.35	1.45	2.33	0.87 pt	25.14
10409	1206, 12 packs of 6 cells	100	\$62.50	\$61.00	STI-1206	1.55	1.55	2.33	0.75 pt	21.60
3496	1801, 18 packs of 1 cell	100	\$59.50	\$58.00	STI-1801	3.10	3.10	2.33	0.64 pt	18.55
11065	2401, 24 packs of 1 cell	100	\$59.50	\$58.00	STI-2401	3.10	2.25	2.33	0.44 pt	12.75

L SERIES SUPER JUMBO/DEEP PACKS, STND 1020 SIZE (20.85" X 10.42") PERFORATED AND EASY TO TEAR					MFG CODE	CELL DIMENSIONS			PACK VOLUME	
ITEM	DESCRIPTION	SHEETS/CASE	1-5 CS	6+ CS		LENGTH	WIDTH	DEPTH	LIQUID	CU. IN.
4443	606, 6 packs of 6 cells	100	\$59.50	\$58.00	ST1606DP	2.35	2.15	3.13	1.29 qt	74.69
3451	804, 8 packs of 4 cells	100	\$58.50	\$57.00	L8045J	2.46	2.47	3.05	1.55 pt	44.44
2805	806, 8 packs of 6 cells	100	\$58.00	\$56.50	ST1806DP	2.35	1.60	3.12	1.64 pt	47.27
11067	1204, 12 packs of 4 cells	100	\$59.00	\$53.00	L1204D	2.63	1.72	2.75	1.02 pt	29.41



# POTS & TRAYS

## L SERIES TRAYS, CARRYING TRAYS AND SEEDER TRAYS (STANDARD 1020 SIZE)

ITEM	DESCRIPTION	PCS/CASE	1-5 CS	6+ CS	MFG CODE	LENGTH	WIDTH	DEPTH
3492	Economical, Solid Side, Web Bottom	50	\$39.55	\$38.00	IL102015S	21.00	10.50	2.50
3595	Heavy Duty, Almost Solid Side, Web Bottom	50	\$51.95	\$49.85	694213	21.10	10.55	2.40
2806	NCR Tray, Solid Side with Bottom Drain Holes	100	\$79.85	\$77.35	710245C	21.22	10.80	2.33
4397	NCRN Tray, Solid Side and Bottom, NO Holes	100	\$82.95	\$80.95	710251C	21.22	10.80	2.33
11068	NCR Tray, Solid Side with Bottom Drain Holes	75	\$94.95	\$92.55	L1020NCR- HD	21.22	10.80	2.33
11069	Open Seeder Tray, Solid Side, Slitted Bottom	100	\$129.00	\$127.00	136ST	21.22	10.80	1.38
4529	10 Row Seeder Tray, Solid Side, Slitted Bottom	100	\$180.00	\$178.00	PSEED10	21.50	11.00	1.25

## PLUG SHEETS

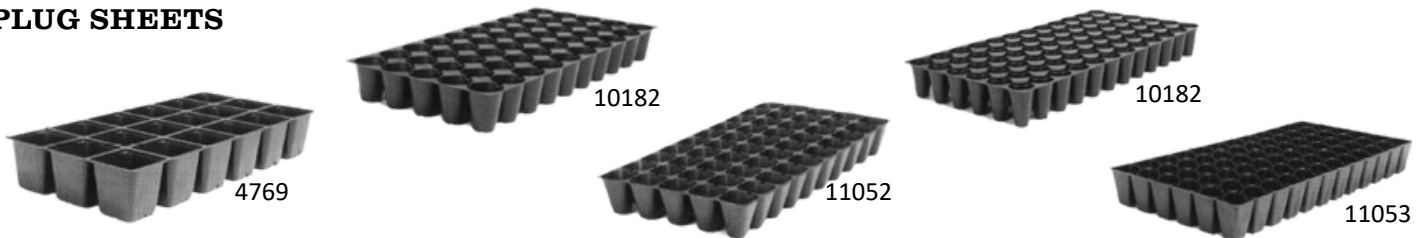

PLUG SHEETS (20.85" X 10.42") STANDARD 1020 SIZE (LIGHTWEIGHT, TO USE WITH A CARRYING TRAY)							CELL CONFIGURATION	TOP DIA.	CU. IN. PER CELL
ITEM	DESCRIPTION	SHEETS/CASE	1-5 CS	6+ CS	MFG CODE	DEPTH			
10181	24 Round	100	\$75.00	\$72.50	24PSD	2.75	3 x 8 Staggered	2.63	8.17
10306	38 Round	100	\$76.00	\$74.00	38PS	2.38	2@7 and 3@8	2.25	6.80
10180	50 Round	100	\$64.00	\$62.00	LPSR050	2.38	5 x 10	2.00	4.60
10182	72 Round	100	\$64.00	\$62.00	72PS	2.38	6 x 12	1.50	2.54
10420	98 Round	100	\$84.00	\$82.00	98PS	1.63	7 x 14	1.38	1.69
4769	18 Square	100	\$65.00	\$64.00	18SPSD	3.23	3 x 6	3.16	23.42
11052	50 Square	100	\$104.00	\$102.00	725616C	2.38	5 x 10	1.93	5.80
11053	72 SQ. w/Root Channels	100	\$75.00	\$73.00	72SPS	2.38	6 x 12	1.63	4.09

## SEEDLING TRAYS



SEEDLING TRAYS (21.23" X 10.8") STANDARD 1020 SIZE (HD, TO USE WITHOUT CARRYING TRAY)							CELL CONFIGURATION	TOP DIA.	CU. IN. PER CELL
ITEM	DESCRIPTION	SHEETS/CASE	1-5 CS	6+ CS	MFG CODE	DEPTH			
4768	30 Ct Rose pot shape w/ channels	50	\$87.00	\$85.00	30ST	3.5	2@8 & 2@7	2.50	10.50
3493	38 Ct Rose pot shape w/ channels	50	\$98.00	\$96.00	38ST	5.00	3@8 & 2@7	2.25	12.10
10423	50 Ct Octagonal w/ round bottom	55	\$108.00	\$106.50	50ST	4.50	5 x 10	1.88	8.80
13354	72 Ct Rose pot shape w/ channels	50	\$87.00	\$85.00	72ST	3.25	6 x 12	1.63	4.20

# POTS & TRAYS

## PLUG TRAYS

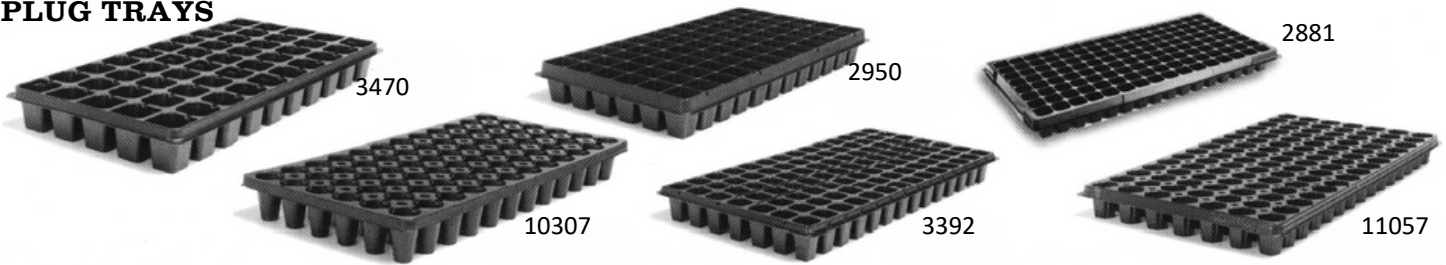

PLUG FLATS (21.38" X 11.05") STANDARD 1020 SIZE (HEAVY-DUTY, TO USE WITHOUT A CARRYING TRAY)							CELL CONFIGURATION	TOP DIA.	CU. IN. PER CELL
ITEM	DESCRIPTION	SHEETS/CASE	1-5 CS	6+ CS	MFG CODE	DEPTH			
3470	50 Square	100	\$122.00	\$120.00	P50	2.25	5 x 10	1.75	5.19
2950	72 Square, Deep	100	\$120.00	\$118.00	P72SQD	2.38	6 x 12	1.63	4.45
10307	72 Round w/Vent Holes	100	\$108.00	\$106.00	72FPT	2.25	6 x 12	1.49	2.52
3392	98 Square	100	\$119.00	\$117.00	P98	2.00	7 x 14	1.25	1.92
2881	128 Square	100	\$102.00	\$100.00	P128	2.00	8 x 16	1.25	1.68
10284	200 Square	100	\$112.00	\$110.00	P200	1.75	10 x 20	0.88	1.29
3457	288 Square	100	\$119.00	\$116.50	P2885Q	1.00	12 x 24	0.75	0.44
10173	288 Square, Deep	100	\$128.00	\$126.00	P2885QD	1.75	12 x 24	0.75	0.61
11054	392 Square	100	\$125.00	\$123.00	P392	1.00	14 x 28	0.63	0.28
11055	406 Square	100	\$122.00	\$120.00	P406	1.00	14 x 29	0.63	0.28
11056	512 Square	100	\$108.00	\$106.00	P512	1.00	16 x 32	0.56	0.24
HEXAGON PLUG FLATS, STANDARD 1020 SIZE (HEAVY-DUTY, TO USE WITHOUT A CARRYING TRAY)							CELL CONFIGURATION	TOP DIA.	CU. IN. PER CELL
ITEM	DESCRIPTION	SHEETS/CASE	PRICE		MFG CODE	DEPTH			
11057	105 w/ Root Channels	100	\$110.00		105HEX	1.5	7 x 15	1.25 x 1.38	1.4

PLANTS PRIDE PLUG TRAYS, STANDARD 1020 SIZE						
ITEM	DESCRIPTION	TRAYS/CS	HEIGHT	CONFIGURATION	THICKNESS (MM)	PRICE EA
YB-162E	162 Octagon	100	4.5	9 X 18	1.0	\$1.15
YB-50M	50 Round	90	6.0	5 X 10	1.0	\$1.05



# POTS & TRAYS

## SQUARE POTS



L SERIES SUPER JUMBO/DEEP PACKS, STND 1020 SIZE (20.85" X 10.42")						DIMENSIONS		VOLUME		COMPATIBLE TRANSPORT TRAYS
ITEM	DESCRIPTION	SHEETS/CASE	1-5 CS	6+ SKID	MFG CODE	DIA.	DEPTH	LIQUID	CU. IN.	
4770	2.25 Square	1,920	\$88.00	\$84.00	225P	2.19	3.00	0.306 pt	8.85	4771
3438	3.00 Square	800	\$43.00	\$42.00	3PF800	2.63	2.25	0.375 pt	10.8	3439
3534	3.00 Square Deep	800	\$41.95	\$40.00	3PD800	2.63	3.50	0.59 pt	17.09	3439
11254	3.25 Sq. Extra Deep	400	\$33.50	\$32.50	3PXD400	3.00	4.25	0.83 pt	23.98	11259
4766	4.00 Square	450	\$38.50	\$37.50	SVD350	3.50	3.50	1.05 pt	30.33	3394
4912	4.00 Sq. Extra Deep	450	\$54.00	\$52.00	4PXD	3.50	5.02	1.52 pt	43.94	3394
3497	4.50 Square	375	\$41.50	\$40.00	45P375	4.19	3.63	1.69 pt	48.82	4446,11260,3523
3440	4.50 Square Deep	375	\$50.50	\$49.00	45PD375	4.19	4.88	1.15 qt	66.64	4446,11260,3523

L SERIES SUPER JUMBO/DEEP PACKS, STND 1020 SIZE (20.85" X 10.42")						DIMENSIONS		VOLUME		COMPATIBLE TRANSPORT TRAYS
ITEM	DESCRIPTION	SHEETS/CASE	1-5 CS	6+ CS	MFG CODE	DIA.	DEPTH	LIQUID	CU. IN.	
11255	4.50 Jumbo Jr Square	375	\$99.00	\$97.00	691525	4.13	5.00	1.05 qt	N/A	4446,11260,3523
11256	5.25 Jumbo Square	200	\$98.00	\$95.00	6915150	5.25	5.25	1.71 qt	N/A	
11257	5.25 Jumbo Senior	200	\$98.00	\$96.00	691535	5.25	6.50	2.03 qt	N/A	
11258	6.00 Magnum Square	150	\$95.00	\$93.00	691543	6.00	6.50	2.79 qt	N/A	11262

## SHEET OF POTS

10459



LIGHTWEIGHT POTS IN A PERFORATED SHEET					MFG CODE	DIMENSIONS		VOLUME		COMPATIBLE TRANSPORT TRAYS
ITEM	DESCRIPTION	SHEETS/CASE	1-5 CS	6+ CS		DIA.	DEPTH	LIQUID	CU. IN.	
10459	3.00 Square, 32 Count	100	\$78.00	\$76.00	3SQSP	2.45 x 2.47	3.00	0.387 pt	11.17	10552
4209	3.50 Sq. Deep, 18 Ct	100	\$96.00	\$94.00	35SPXD	3.48 x 3.47	3.50	0.92 pt	26.55	3394
4445	4.50 Square, 15 Count	100	\$141.00	\$139.00	45SP	4.09 x 4.09	3.65	1.55 pt	44.85	4446

## SQUARE POT TRAYS



SQUARE POT TRAYS						DIMENSIONS			COMPATIBLE SQUARE POTS
ITEM	DESCRIPTION	SHEETS/CASE	1-5 CS	6+ CS	MFG CODE	LENGTH	WIDTH	DEPTH	
4771	2.25 Sq. Pot Tray, 32 Count	100	\$98.00	\$97.00	2SPT32	18.10	9.12	2.25	4770
3439	3.00 Sq. Pot Tray, 32 Count	100	\$93.50	\$92.00	LPF32TRY	21.23	10.79	1.50	3438
10552	3.00 Sheet of Pots Tray, 32 Ct	100	\$112.00	\$110.00	3SPT32	21.23	10.79	2.00	10459
11259	3.25 Sq. Extra Deep Tray, 20 Ct	100	\$114.00	\$112.50	3PXD20	15.19	12.19	2.00	11254
3394	4.00 Sq. Pot Tray, 18 Count	50	\$45.50	\$44.00	SPT 350	21.23	10.79	2.31	4766,4912
4446	4.50 Sq. Pot Tray, 15 Count	50	\$57.50	\$56.00	LPF15TRY	21.10	12.71	2.31	3497,3440,11255,4445
11260	4.50 Sq. Pot Tray, 12 Count	100	\$108.50	\$106.50	L45PF12	16.97	12.75	2.31	3497,3440,11255
3523	4.50 Sq. Pot Tray, 10 Count	90	\$73.50	\$72.00	45SPT10	20.94	8.44	2.02	3497,3440,11255
11261	Jumbo Sq. Pot Tray, 8 Count	50	\$190.00	\$187.00	698140	21.25	10.90	3.25	11256
11262	Magnum Sq. Pot Tray, 6 Count	50	\$165.00	\$164.00	694225	18.00	12.00	3.25	11258

# POTS & TRAYS

## ROUND THERMOFORMED POTS

2799



13136



3436



3434



11265



11266



FLEXIBLE SIDEWALL WITH RIM DESIGN THAT HAS GOOD HOOP STRENGTH						DIMENSIONS		VOLUME		COMPATIBLE TRAYS
ITEM	DESCRIPTION	PCS/CASE	1-5 CS	6+ CS	MFG CODE	DIA.	DEPTH	LIQUID	CU. IN.	
2799	4.00 Round, Black	825	\$69.50	\$68.00	4RMGT	4.0"	3.49	1.02 pt	29.4	15249
4578	4.50 Geranium, Black	450	\$49.00	\$48.00	45RMGT	4.5"	4.02	1.37 pt	39.7	2803, 11275
13136	4.50 Geranium, Terra-Cotta	450	\$74.00	\$73.00	45RMGT	4.5"	4.02	1.37 pt	39.7	2803, 11275
3436	5.00 Azalea, Black	440	\$53.00	\$52.00	5AMGT	5.0"	3.61	1.67 pt	48.21	3435
14790	5.00 Azalea, Terra-Cotta	440	\$76.00	\$74.00	5AMGT	5.0"	3.61	1.67 pt	48.21	3435
3434	6.00 Azalea, Black	220	\$38.00	\$37.00	6AMGT	6.0"	4.38	1.40 qt	81.04	3442
658	6.00 Azalea, Terra-Cotta	220	\$54.00	\$53.00	6AMGT	6.0"	4.38	1.40 qt	81.04	3442
14791	6.50 Azalea, Black	240	\$40.00	\$38.00	65AMGT	6.5"	5.00	2.08 qt	120.12	13355
12511	6.50 Azalea, Terra-Cotta	240	\$57.00	\$55.00	65AMGT	6.5"	5.00	2.08 qt	120.12	13355
11266	7.50 Azalea, Black	220	\$62.70	\$61.00	75AMGT	7.5"	5.71	3.02 qt	174.5	

## ROUND INJECTION MOLDED POTS

FLEXIBLE SIDEWALL WITH RIM DESIGN THAT HAS GOOD HOOP STRENGTH						DIMENSIONS		VOLUME		COMPATIBLE TRAYS
ITEM	DESCRIPTION	PCS/CASE	1-5 CS	6+ CS	MFG CODE	DIA.	DEPTH	LIQUID	CU. IN.	
11267	Clay 3.00 Standard	1,750	\$174.25	\$172.50	Koba	3"	2.75	7.0 fl oz	12.63	11274
11268	Black 4.50 Ger	900	\$119.75	\$118.25	Koba	4.5"	3.63	1.28 pt	37.90	11275, 2803
4349	Green 4.50 Azalea	900	\$120.95	\$119.25	Koba	4.5"	3.63	1.28 pt	37.90	11275, 2803
11269	Black 6.50 Azalea	200	\$84.00	\$82.00	Koba	6.5"	5.13	1.66 qt	115.52	13355
11047	Green 6.50 Azalea	246	\$85.00	\$84.00	Koba	6.5"	5.13	1.66 qt	115.52	13355
11270	Green 7.00 Azalea	164	\$127.00	\$125.00	Koba	7"	5.50	2.16 qt	151.62	-
11271	Green 8.00 Azalea	264	\$119.95	\$118.50	Koba	8"	6.25	1.00 gal	231.04	-
11272	Green 10.00 Azalea	36	\$45.00	\$43.00	Koba	10"	7.50	1.75 gal	404.32	-
11273	Black 12.00 Azalea	25	\$83.00	\$81.00	Belden	12"	9.00	3.00 gal	0.00	-

## ROUND POT TRANSPORT TRAYS



2802

11275



3442



FLEXIBLE SIDEWALL WITH RIM DESIGN THAT HAS GOOD HOOP STRENGTH						DIMENSIONS			COMPATIBLE POTS
ITEM	DESCRIPTION	PCS/CASE	1-5 CS	6+ CS	MFG CODE	LENGTH	WIDTH	DEPTH	
11274	3.00 12 Count 3x4	130	\$209.00	\$205.00	Koba	12.00	9.00	3.00	11267
2802-100	4.00 15 Count 3x5	100	\$134.00	\$132.00	4TP15PS	20.25	12.13	3.50	2799
2803	4.50 15 Count 3x5	90	\$159.00	\$157.00	45TPPP	23.06	14.06	3.94	4578, 11268, 3136, 4349
11275	4.50 12 Count 3x4	75	\$98.00	\$96.00	45TP12	18.99	14.11	3.96	4578, 11268, 3136, 4349
3435	5.00 8 Count 2x4	100	\$114.50	\$112.50	T5TP	20.00	10.00	3.75	3436
3442	6.00 6 Count 2x3	100	\$125.00	\$126.00	6TP	17.64	11.50	4.25	3434, 658
13355	6.50 6 Count 2x3	100	\$142.00	\$140.00	65TPH	19.63	13.00	5.25	4791, 12511, 11209, 11047

Prices are subject to change without notice. Kindly contact us at (508) 273-7358 to verify pricing.



# POTS & TRAYS

## NURSERY CONTAINERS, THERMOFORMED

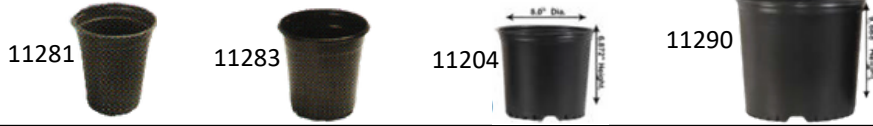

FLEXIBLE SIDEWALL WITH RIM DESIGN THAT HAS GOOD HOOP STRENGTH						DIMENSIONS		VOLUME		COMPATIBLE TRAYS
ITEM	DESCRIPTION	PCS/CASE	1-5 CS	6+ CS	MFG CODE	DIA.	DEPTH	LIQUID	CU. IN.	
11281	True Quart, 4.75" Black	600	\$80.00	\$78.00	TQTMGT	4.75	5.27	1.02 qt	59.10	11297
10341	Trade Gallon, 6.5" Black	200	\$34.00	\$33.00	65NTGT	6.50	6.50	2.50 qt	144.00	11298
11286	Trade 2 Gallon, 8.5" Black	100	\$38.00	\$37.00	85NT2G	8.50	9.00	1.50 gal	346.20	
11284	True Gallon, 8" Black	170	\$60.00	\$58.00	HP-100	8.00	6.87	1.00 gal	231.00	
11288	Trade 2 Gallon, 9" Black	150	\$72.50	\$69.50	HP-175	9.00	8.50	1.50 gal	346.00	
11289	True 2 Gallon, 9.75" Black	140	\$65.75	\$63.00	HP-200	9.75	9.12	2.00 gal	462.00	
11290	True 3 Gallon, 11" Black	120	\$78.00	\$76.00	HP-300	11.00	9.69	3.00 gal	693.00	
13359	True 4 Gallon, 12.2" Black	55	\$78.00	\$76.00	HP-500	12.22	11.63	4.02 gal	924.00	

## NURSERY CONTAINERS, INJECTION MOLDED

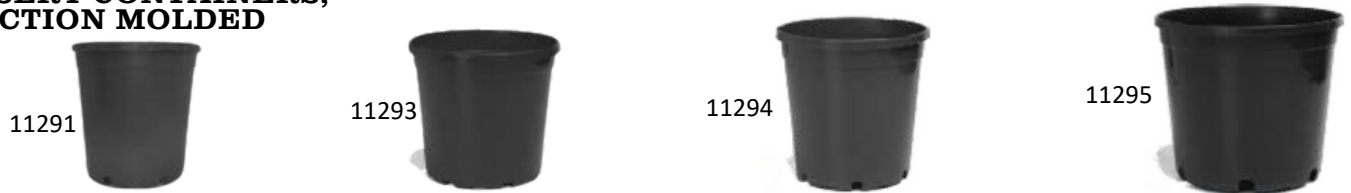

HEAVY DUTY, RIGID						DIMENSIONS		VOLUME		COMPATIBLE TRAYS
ITEM	DESCRIPTION	PCS/CASE	1-5 CS	6+ CS	MFG CODE	DIA.	DEPTH	LIQUID	CU. IN.	
11291	Black 300 Trade Gallon	68	\$48.00	\$46.00	INCTGAL	6.13	6.87	2.64 qt	152.06	11299
11292	Terra-Cotta 300 Trade Gal	68	\$49.00	\$47.00	INCTGAL	6.13	6.87	2.64 qt	152.06	11299
11293	Black 400 True Gallon	75	\$84.00	\$82.00	INCSGAL	7.15	7.00	1.01 gal	232.38	
11294	Black 600 Trade 2 Gallon	65	\$82.00	\$80.00	INCT2GAL	8.04	8.50	1.47 gal	339.17	
3535	Terra-Cotta 600 Trade 2 Gal	65	\$98.00	\$96.00	INCT2GAL	8.04	8.50	1.47 gal	339.17	
11295	Black 1000 Trade 3 Gallon	59	\$148.60	\$146.00	INCT3GAL	10.41	9.50	2.79 gal	644.41	

## NURSERY CONTAINER, HPP BLOW MOLDED



BLACK FLEXIBLE POTS WITH ROUNDED TOP RIM THAT HAS MULTIPLE HANDLE GRIPS						DIMENSIONS		VOLUME	
ITEM	DESCRIPTION	PCS/CASE	1-5 CS	6+ CS		DIA.	DEPTH	LIQUID	CU. IN.
13140	5 Gallon, 500 Squat Series	30	\$50.00	\$48.00		14.00	10.00	5.00 gal	1,155
13138	6 Gallon, 700 Series	30	\$72.55	\$71.25		14.00	11.50	6.08 gal	1,405
ITEM	POTS BELOW SOLD BY THE PIECE	1-99		100- SKID		DIA.	DEPTH	LIQUID	CU. IN.
11304	10-1/2 Gal, 1000 SQUAT Series	\$5.75		\$5.65		16.50	14.75	10.67 gal	2,465
11305	13-1/2 Gallon, 1500 Series	\$4.85		\$4.65		18.20	16.00	13.66 gal	3,155
11306	20 Gallon, 2000 Series	\$8.25		\$7.75		20.00	17.00	20.04 gal	4,629
11307	27-1/2 Gallon, 2500 Series	\$8.75		\$8.05		24.00	18.00	27.50 gal	6,353

# POTS & TRAYS

## NURSERY CONTAINER, TRANSPORT TRAYS



11297



11298



11299

NURSERY CONTAINER CARRYING TRAYS						DIMENSIONS			COMPATIBLE POTS
ITEM	DESCRIPTION	PCS/CASE	1-5 CS	6+ CS	MFG CODE	LENGTH	WIDTH	DEPTH	
11297	4.75" True Quart, 8 Count	75	\$89.00	\$88.00	QTTWL8	19.50	10.00	5.30	11281
11298	6.50" Trade Gallon, 6 Count	50	\$83.00	\$81.00	TGOF6	19.63	13.00	6.71	11283
11299	300 Trade Gallon, 6 Count	50	\$58.00	\$56.00	3QTCT	19.50	12.75	2.50	11291, 11292

## MUM PANS



3437



11280



3453



13356

THERMOFORMED HAS A FLEXIBLE SIDEWALL WITH RIM DESIGN THAT HAS GOOD HOOP STRENGTH						DIMENSIONS		VOLUME	
ITEM	DESCRIPTION	PCS/CASE	1-5 CS	6+ CS	MFG CODE	DIA.	DEPTH	LIQUID	CU. IN.
13378	8.00 Black, Thermoformed	130	\$41.80	\$40.00	8MPMGT	8.0	5.0	3.04 qt	175.44
11278	8.00 Terra-Cotta, Thermoformed	130	\$59.00	\$58.00	8MPMGT	8.0	5.0	3.04 qt	175.44
11280	8.00 Green, Injection Molded	258	\$268.00	\$260.00	IMP800	8.0	5.0	3.09 qt	178.5
11276	9.00 Black, Thermoformed	140	\$48.00	\$46.00	9MPMGT	9.0	5.9	1.18 gal	271.9
3453	9.00 Terra-Cotta, Thermoformed	130	\$63.50	\$62.00	9MPMGT	9.0	5.9	1.18 gal	271.9
11277	9.00 Green, Thermoformed	140	\$62.50	\$61.50	9MPMGT	9.0	5.9	1.18 gal	271.9
13356	10" Black Haviland, Thermoformed	125	\$79.00	\$77.00	HP-10M	10.75	7.85	2.25 gal	520
13357	10" Terra-Cotta Haviland, Thermoformed	125	\$98.00	\$96.00	HP-10M	10.75	7.85	2.25 gal	520

## JIFFYSTRIPS®

These peat pots are 100% biodegradable and come in strips that fit in standard 1020 trays and can be torn into individual pots for easy planting.



4317



4714

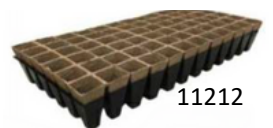

11212

ITEM	POT DIAMETER	POTS/STRIP	POTS/CS	1-5 CS	6+ CS
4317	#525 fits 32 pots/Std. 1020 tray	2.50"	8	\$154.00	
4714	#516 Strip only, fits 50ct in 1020 tray	1.75"	10	\$195.00	\$192.00
11212	#519 Strips in Polypak, 72 Count	1.50"	12	\$269.00	\$264.00

## CUT FLOWER BUCKET

SOLID BASE ALLOWING FOR TOP-HEAVY BLOOMS			PRICE PER CASE			MFG CODE	DIMENSIONS		VOLUME	
ITEM	DESCRIPTION	PCS/CASE	1-5 CS	6+ CS	SKID QTY		DIA.	DEPTH	LIQUID	CU. IN.
11233	10" Black, no holes	30	\$47.85	\$46.35	40	KOBA	10.00	9	2.25 gal	519.8

## Bamaplast



15584



15583

## NURSERY POT - SQUAT

## Bamaplast



ITEM	DESCRIPTION	MFG CODE	HEIGHT CM	LITERS	PRICE/EA
15584	Cut Flower Bucket 3.0 gal	28/F	26	11	\$1.44

ITEM	DESCRIPTION	MFG CODE	HEIGHT IN.	LITERS	PRICE/EA
15577	Nursery Pot 4.0 gal Squat	30/B	26	15	\$2.65
15576	Nursery Pot 6.5 gal Squat	35/B	28	25	\$4.56



# POTS & TRAYS

## VERTPAC PLANT SLEEVES



### Paper sleeves

Paper sleeves are made with heavy duty wet strength paper

ITEM	DIMENSIONS	DESCRIPTION	PRICE
16104	6 - 18	6 - 6.5 Inch Pot - 500/box	\$135.00
8652	6 - 36	6 - 6.5 Inch Pot - 250/box	\$145.00
9051	7 - 36	7 Inch Pot - 250/box	\$85.00
16080	9 - 60	9 Inch - 100/sleeve	\$47.65

### Satin sleeves

Satin sleeves are designed with high-density polyethylene with vent holes for air circulation

ITEM	DIMENSIONS	DESCRIPTION	PRICE
16079	5.5 X 13 X 18	4 - 4.5 Inch Pot - 500/sleeve	\$89.50
16074	8 X 20 X 24	6 - 6.5 Inch Pot - 1,000/sleeve	\$105.60
16076	8 X 24 X 24	6 - 6.5 Inch Pot - 1,000/sleeve	\$117.60
17001	9 X 24 X 30	7 - 7.5 Inch Pot - 1,000/sleeve	\$154.80
16077	10.5 X 30 X 30	8 Inch Pot - 1,000/sleeve	\$186.00
16078	13.5 X 34 X 30	10 Inch Pot - 500/sleeve	\$220.80

## HUMIDITY DOMES

- Plastic Domes Match with Seed Tray to Create a Mini Greenhouse
- Professional quality domes are thick and sturdy.
- Adjustable top vents allow for perfect humidity and temperature control.
- Create a mini greenhouse environment - perfect for growing microgreens and starting seeds when combined with seed starting inserts.
- Clear PVC Material



ITEM	DESCRIPTION	PRICE
12562	Standard Domes, 21 1/4" x 11" 2 1/2 - 5 pack	\$12.00
3601	Standard Domes, 21 1/4" x 11" 2 1/2 - 50 pack	\$70.00
14683	Mid Height Domes (Top Vent) - each	\$2.95
11156	Tall Domes, 21 1/4" x 11" x 7" (Top Vent) - each	\$4.35

## SQUARE BAND POTS



15453



15461



15462



ITEM	DESCRIPTION	MFG CODE	DIMENSIONS	PRICE/EA
15461	Square Band Pot	2008P	2 7/8" x 5 1/2"	\$0.31
15462	Square Band Pot	2006P	3 5/8" x 6"	\$0.45

## MARKET PACKS & HANDLES



3 OF THESE FIT PER TRAY #3433			PRICE PER CASE			MFG CODE	DIMENSIONS			VOLUME	
ITEM	DESCRIPTION	PCS/CASE	1-5 CS	6+ CS	SKID QTY		LENGTH	WIDTH	DEPTH	LIQUID	CU. IN.
11252	306 Pack, T Pot 6 Count	300	\$90.00	\$88.00	32	TPP6	10.11	6.73	3.5	0.72 pt	20.75
15488	19" White Handle	100	\$37.75	\$35.50	20/CS	DN1481	19	1	-	-	-

# POTS & TRAYS

## HANGING BASKETS



3458



11308



11310



10232

HANGING BASKETS, LANDMARK PLASTICS					MFG CODE	DIMENSIONS		VOLUME		COMPATIBLE HANGERS
ITEM	DESCRIPTION SAUCERLESS = INSIDE SAUCER	PCS/ CASE	PRICE	SKID QTY		DIA.	DEPTH	LIQUID	CU. IN.	
4211	White 10" Imperial Deco, Saucerless	50	\$44.00	50	IHHB10	10	6.5	1.5	346.5	4364/4810/10324
4210	Green 10" Imperial Deco, Saucerless	50	\$40.50	50	IHHB10	10	6.5	1.5	346.5	4171/4170/10324
11308	Choc. Brown 10" Imperial, Saucerless	50	\$56.95	50	IHHB10	10	6.5	1.28	346.5	4444/10324
3458	White 10" Contempo Swirl, Saucerless	50	\$47.00	50	ICT10	9.88	6	1.28	295.05	4364/4810/10324
3459	Green 10" Contempo Swirl, Saucerless	50	\$45.00	50	ICT10	9.88	6	1.28	295.05	4171/4170/10324
12849	White 12" Deco Swirl, Saucerless	25	\$50.00	48	IDS12	11.81	7.22	2.25	520.23	10267/11312
10232	Green 12" Deco Swirl, Saucerless	25	\$50.00	48	IDS12	11.81	7.22	2.25	520.23	12030/11312
14792	Black 12" Deco Swirl, Saucerless	25	\$59.95	48	IDS12	11.81	7.22	2.25	520.23	14793/11312
HANGING BASKETS, LANDMARK PLASTICS					MFG CODE	DIMENSIONS		VOLUME		COMPATIBLE HANGERS
ITEM	DESCRIPTION SAUCERLESS = INSIDE SAUCER	PCS/ CASE	PRICE	SKID QTY		DIA.	DEPTH	LIQUID	CU. IN.	
11310	White 11" Traditional, Saucerless	50	\$69.75	40	ICHB11W	11	7.22	1.75	400	3460/4364/10324
15315	Green 11" Traditional, Saucerless	50	\$69.75	40	ICHB11G	11	7.22	1.75	400	3461/4171/10324

## HANGERS, FOR BASKETS

ITEM	DESCRIPTION	PCS/PK	PRICE PER PACK	MFG CODE	TYPE	COMPATIBLE POTS
4364	White 16" Plastic, 3 Strand	25	\$9.50	116ACL	Double Clip	4211/3458/11310
4171	Green 16" Plastic, 3 Strand	25	\$9.50	116ACL	Double Clip	4210/3459/11311
4810	White 19" Plastic, 3 Strand	25	\$12.00	1195PCL	Snap Clip	4211/3458/11311
4170	Green 19" Plastic, 3 Strand	25	\$12.00	1195PCL	Snap Clip	4210/3459
4444	Choc. Brown 19" Plastic, 3 Strd	25	\$12.00	1195PCL	Snap Clip	11308
10267	White 22" Plastic, 4 Strand	25	\$8.80	K22ACL	Double Clip	10266
12030	Green 22" Plastic, 4 Strand	25	\$8.50	K22ACL	Double Clip	10232
14793	Black 22" Plastic, 4 Strand	25	\$8.80	K22ACL	Double Clip	14792
10324	21" Wire 3 Strand, Galvanized	50	\$13.80	Z21LH50	Wrapped Wire	4211/3458/11310
11312	24" Wire 4 Strand, Galvanized	50	\$16.60	Z24164STW	Wrapped Wire	10266



# POTS & TRAYS

## HANGING BASKETS



6" THROUGH 12" INCLUDE PLASTIC HANGERS, 14" INCLUDE WIRE						HANGERS (INCLUDED)	DIMENSIONS		VOLUME	
ITEM	DESCRIPTION SAUCERLESS = INSIDE SAUCER	PCS/ CASE	1-5 CS	6+ CS	SKID QTY		DIA.	DEPTH	LIQUID	CU. IN.
15317	White 4.5" Traditional w/ Snap-on Saucer	132	\$165.00	\$163.00	18	12", 3 Strand	4.5	4.38	1.60 pt	46.93
4531	White 6" Traditional w/Snap-on Saucer	160	\$159.80	\$157.75	18	12" 3 Strand	6.0	4.13	1.16 qt	68.59
10265	White 8" Fluted, Saucerless	84	\$90.00	\$88.00	50	17" 3 Strand	8.0	5.13	.70 gal	162.4
15318	Green 8" Fluted, Saucerless	84	\$95.00	\$93.00	50	17", 3 Strand	8.0	5.13	.70 gal	162.4
11201	White 10.5" Trench Tek	96	\$98.00	\$97.00	40	17", 3 Strand	10.5	6.00	1.25 gal	288.6
11202	Tera-Cotta 10.5" Trench Tek	96	\$99.00	\$97.00	40	17", 3 Strand	10.5	6.00	1.25 gal	288.6
11203	White 11" Traditional, Trench Tek	50	\$54.50	\$53.00	32	19", 3 Strand	11	6.38	1.73 gal	400.2
10266	Green 11" Traditional, Trench Tek	50	\$55.0	\$53.00	32	19", 3 Strand	11	6.38	1.73 gal	400.2
14794	Black 11" Traditional, Trench Tek	50	\$55.00	\$53.00	32	19", 3 Strand	11	6.38	1.73 gal	400.2
<b>TRENCH TEK HANGING BASKETS. BASE DESIGN ELIMINATES NEED FOR INSIDE SAUCER RESULTING IN LESS LABOR AND COST</b>										
11204	White 12" Curved, Saucerless	50	\$114.95	\$112.75	24	22" 4 Strand	12	7.25	2.37 gal	548.7
12581	Terra-cotta 12" Curved, Saucerless	50	\$115.95	\$113.00	24	22" 4 Strand	12	7.25	2.37 gal	548.7
15319	Green 12" Curved, Saucerless	50	\$115.95	\$113.00	24	22", 4 Strand	12	7.25	2.37 gal	548.7
11206	White 14" Curved, Saucerless	60	\$196.50	\$194.50	27	26" 4 Str. Wire	14	7.75	3.04 gal	703.7
11207	Terra-cotta 14" Curved, Saucerless	60	\$198.50	\$196.50	27	26" 4 Str. Wire	14	7.75	3.04 gal	703.7



ITEM	COLOR	DESCRIPTION	DIAMETER	VOLUME (GAL/L)	HOOK LENGTH(INCH/CM)	PRICE
YB-HB801BLK	Black	8" Hanging Basket	7.87"   20	0.74 / 2.8	15"/38	\$1.25
YB-HB801DG	Dark Green					
14824	White	10" Hanging Basket	9.25"   23.5	1.5/5.6	18.35" / 46.7	\$1.50
14821	Choc. Brown					
14823	Green					
YB-HB1004	Tan					
YB-HB1002BL	Black					
14825	White	12" Hanging Basket	11.1" / 28.2	2.32/8.78	22.3" / 56.63	\$2.25
YB-HB1201BL	Black					

# POTS & TRAYS

## HANGING BASKETS



COCO FIBER NEST BASKETS, BLACK WIRE			PRICE PER CASE			MFG CODE	DEPTH	VOLUME
ITEM	DESCRIPTION	PCS/CASE	1-5 CS	6+ CS	SKID QTY			
11239	12" Coco Fiber Nest Basket	12	\$115.00	\$112.00	36	400-J12CO	6.5"	2.13 gal
11240	14" Coco Fiber Nest Basket	12	\$128.00	\$126.00	45	400-J14CO	7.0"	3.13 gal
11241	16" Coco Fiber Nest Basket	12	\$150.00	\$145.00	30	400-J16CO	7.0"	4.25 gal
BLACK WIRE HANGERS FOR ALL ABOVE BASKETS								
11242	22" 3 Strand, Open Hook Hanger	12	\$38.00	\$36.00	30	400-HK22PN	-	-
PRE-FORMED REPLACEMENT COCO NEST LINERS								
11243	12" Coco Replacement Liner	12	\$28.00	\$26.50	36	401-L12	-	-
11244	14" Coco Replacement Liner	12	\$36.95	\$35.95	36	401-L14	-	-
11245	16" Coco Replacement Liner	12	\$43.00	\$41.00	36	401-L16	-	-
DECORATIVE BASKETS, NATURAL BARK AND WICKER WITH PLASTIC LINER								
ITEM	DESCRIPTION	PCS/CASE	1-5 CS	6+ CS	SKID QTY	MFG CODE	DEPTH	VOLUME
11246	14" Flat Bark Basket	12	\$115.00	\$113.00	24	750-61	6.0"	2.00 gal
11247	14" Cone Bark Basket	12	\$115.00	\$113.00	24	750-62	15.0"	2.25 gal
11248	14" Cone Wicker & Rice Basket	12	\$105.00	\$103.00	24	750-12	15.0"	2.25 gal
12500	14" Cone Green Rope & Twig Basket	12	\$119.00	\$117.00	24	750-36	15.0"	2.25 gal
12501	14" Cone Black & Tan Rope Basket	12	\$128.00	\$126.00	24	750-70	15.0"	2.25 gal
11249	Wire stand for Cone Baskets	30	\$83.00	\$81.00	12	780-VAL	-	-
GALVANIZED HANGERS FOR ALL ABOVE BASKETS								
11250	22" 3 Strand, Galvanized WIRE Hanger	12	\$14.75	\$14.25	24	400-HK22	-	-
11251	22" 3 Strand, Galvanized CHAIN Hanger	12	\$42.50	\$41.00	24	400-CH22	-	-



# POTS & TRAYS

## DECORATIVE PLANTERS



3599

14796

14203

11217

11221

11219

KHAN SATURN POTS, ROUND			PRICE PER CASE			MFG CODE	DIMENSIONS		VOLUME	
ITEM	DESCRIPTION	PCS/CASE	1-5 CS	6+ CS	SKID QTY		DIA.	DEPTH	LIQUID	CU. IN.
3455	10" Terra-Cotta	50	\$67.95	\$65.00	40	KSAT10	11.48	7.86	2.05 gal	473.6
4380	12" Terra-Cotta	40	\$76.95	\$74.95	30	KSAT12	13.45	9.27	3.45 gal	797.3
3599	14" Terra-Cotta	30	\$98.75	\$96.25	16	KSAT14	15.87	11.19	5.76 gal	1330.6
14796	14" Fluted, Terra-Cotta	30	\$73.00	\$71.00	16	KFPN14	14.25	9.50	3.62 gal	836.6
HICKORY BARREL (WOOD LOOK) ROUND			PRICE PER CASE			MFG CODE	DIMENSIONS		VOLUME	
ITEM	DESCRIPTION	PCS/CASE	1-5 CS	6+ CS	SKID QTY		DIA.	DEPTH	LIQUID	CU. IN.
14203	10.5" Chocolate Brown	80	\$89.95	\$86.95	32	KCT270	10.50	7.50	1.83 gal	422
14797	13" Chocolate Brown	40	\$88.00	\$85.00	36	KCT340	13.00	9.60	3.5 gal	805
14798	14.5" Chocolate Brown	30	\$94.50	\$92.50	36	KCT380	14.50	10.50	4.5 gal	1036
2 PIECE SPARTA URN			PRICE PER CASE			MFG CODE	DIMENSIONS		VOLUME	
ITEM	DESCRIPTION	PCS/CASE	1-5 CS	6+ CS	SKID QTY		DIA.	DEPTH	LIQUID	CU. IN.
11217	12" White Urn	25	\$78.95	\$76.95	48	KCZ305	11.8	11.6	1.6 gal	374
11218	12" Black Urn	25	\$68.95	\$66.95	48	KCZ305	11.8	11.6	1.6 gal	374
BOTANICA SERIES, LARGE ROUND			PRICE PER CASE			MFG CODE	DIMENSIONS		VOLUME	
ITEM	DESCRIPTION	PCS/CASE	1-5 CS	6+ CS	SKID QTY		DIA.	DEPTH	LIQUID	CU. IN.
11219	17.75" Tan, Vineyard	15	\$105.00	\$103.00	18	KCFP18	17.75	13.75	8.10 gal	1,886
11220	17.75" Bronze, Vineyard	20	\$105.65	\$103.00	18	KCFP18	17.75	13.75	8.10 gal	1,886
11221	17.5" Bronze, Prestige	20	\$142.00	\$139.00	18	KCF018	17.50	14.25	7.85 gal	1,814





# POTS & TRAYS

## DECORATIVE PLANTERS



TREASURE BOWLS			PRICE PER CASE			MFG CODE	DIMENSIONS		VOLUME	
ITEM	DESCRIPTION	PCS/CASE	1-5 CS	6+ CS	SKID QTY		DIA.	DEPTH	LIQUID	CU. IN.
4381	12" Terra-Cotta	50	\$68.95	\$66.95	48	KTSB12	12	5.67	1.55 gal	359.1
11222	12" Choc. Brown	50	\$72.95	\$71.65	48	KTSB12	12	5.67	1.55 gal	359.1
3456	14" Terra-Cotta	50	\$86.95	\$84.95	36	KTSB14	14	5.75	2.09 gal	482.1
SERENE SQUARES			PRICE PER CASE			MFG CODE	DIMENSIONS		VOLUME	
ITEM	DESCRIPTION	PCS/CASE	1-5 CS	6+ CS	SKID QTY		DIA.	DEPTH	LIQUID	CU. IN.
11223	7.50" Tan	100	\$89.50	\$87.50	60	KSMSQ75	7.50	7.25	1.11 gal	256.7
14078	11.50" Terra-Cotta	25	\$58.95	\$57.25	48	KSMQ115	11.50	10.00	3.50 gal	807.5
OVALS			PRICE PER CASE			MFG CODE	DIMENSIONS		VOLUME	
ITEM	DESCRIPTION	PCS/CASE	1-5 CS	6+ CS	SKID QTY		DIA.	DEPTH	LIQUID	CU. IN.
11225	12" Panterra, ITML	50	\$133.00	\$130.00	64	PAP1200	13x6.5	5	0.97 gal	223.0
3454	16" Khan Fluted	50	\$94.75	\$92.00	36	KOVL16	16x6.75	6	1.82 gal	419.5
3588	Saucer for 16" Oval	50	\$44.00	\$42.00	72	KOVSL16	14.6x5.7	1	-	-
PLANTER BOX, RECTANGLE			PRICE PER CASE			MFG CODE	DIMENSIONS		VOLUME	
ITEM	DESCRIPTION	PCS/CASE	1-5 CS	6+ CS	SKID QTY		DIA.	DEPTH	LIQUID	CU. IN.
11226	7x14" Terra-Cotta	100	\$186.00	\$184.00	36	X714PB	7x14	4.19	1.36 gal	315.19





# POTS & TRAYS

## DECORATIVE PLANTERS

Drain holes are not pre-punched on above 16, 20 & 25" pots.



11234



11233



11231



11229



TREASURE BOWLS			PRICE PER CASE			MFG CODE	DIMENSIONS		VOLUME	
ITEM	DESCRIPTION	PCS/CASE	1-5 CS	6+ CS	SKID QTY		DIA.	DEPTH	LIQUID	CU. IN.
11227	8" Terra-cotta, Trench Tek	150	\$108.65	\$107.15	24	KOBA	8.00	6.00	0.8 gal	184.79
11228	10" Terra-cotta, Trench Tek	70	\$85.25	\$84.35	32	KOBA	10.00	7.50	1.8 gal	425.9
11229	12" Terra-cotta	48	\$89.75	\$88.65	24	KOBA	12.00	9.00	3.5 gal	808.6
11230	14" Terra-cotta	20	\$69.65	\$67.00	27	KOBA	14.00	11.75	5.5 gal	1270.7
CURVE DECK POTS, ROUND (MADE IN USA)			PRICE PER CASE			MFG CODE	DIMENSIONS		VOLUME	
ITEM	DESCRIPTION	PCS/CASE	1-5	6+	SKID QTY		DIA.	DEPTH	LIQUID	CU. IN.
11232	16" Slate color	18	\$87.85	\$86.25	18	KOBA	16.00	12.2	6 gal	1418.8
15831	16" Honeysuckle Color	600	\$2,275.00 Bulk skid			KOBA	16.00	12.2	6 gal	1418.8
14096	20" Terra-Cotta Color	Per Pc	\$9.85	\$9.60	120 pcs	KOBA	20.00	15.5	13.5 gal	3118.8
14097	20" Honeysuckle Color	Per Pc	\$9.85	\$9.60	120 pcs	KOBA	20.00	15.5	13.5 gal	3118.8
15768	25" Slate Color	Per Pc	\$19.75	\$17.75	100 pcs	KOBA	25.00	18.5	21.37 gal	4938.1

## GROW PANS

Compatible hangers optimize greenhouse growing space.

TRENCH TEK BOTTOM CONSERVES WATER			PRICE PER CASE			COMPATIBLE HANGERS	DIMENSIONS		VOLUME	
ITEM	DESCRIPTION	PCS/CASE	1-5 CS	6+ CS	SKID QTY		DIA.	DEPTH	LIQUID	CU. IN.
11234	8" Green Deko Pan	246	\$173.00	\$170.00	18	4171, 10324	8.00	4	0.525 gal	125
11235	10" Green Deko Pan	130	\$122.35	\$119.75	40	4171, 10324	10.00	4.5	1.05 gal	248
11236	12" Green Deko Pan	116	\$168.45	\$166.00	24	12030, 11312	12.00	5	1.56 gal	365

## TRUE SERIES INSERTS & TRAYS

True 10" x 12" size (These are NOT standard size.)

ITEM	DESCRIPTION	PCS/CASE	1-5 CS	6+ CS	MFG CODE	LENGTH	WIDTH	DEPTH	LIQUID	CU. IN.
3431	T 804 Pack	100	\$59.50	\$58.00	T804	2.28	2.24	2.61	1.52 pt	44.00
4377	T 806 Pack	100	\$55.00	\$53.00	T806	2.28	1.50	2.61	1.42 pt	40.90
80-0195	T 1204 Pack	100	\$54.00	\$52.00	T1204	2.25	1.45	2.61	0.94 pt	27.16
11661	T 606 Super Jumbo Pack	100	\$61.50	\$60.00	T606SJ	2.21	2.03	3.25	1.14 qt	65.54
15798	T 804 Super Jumbo Pack	100	\$61.50	\$60.00	T804SJ	2.23	2.30	3.25	1.66 pt	47.99
3432	T 1801 Sheet of Pots	100	\$64.00	\$62.00	T1801SP	3.14	3.18	3.27	0.78 pt	22.58
3433	T Web Bottom Carrying Tray	100	\$70.00	\$68.00	ITIM	20.00	10.00	2.63	-	-
15799	T NCR Tray, Solid, w/Drain holes	100	\$87.00	\$84.00	TNCRXD	20.00	10.00	2.71	-	-

# POTS & TRAYS

## WHITE PLASTIC LABELS & SIGNS

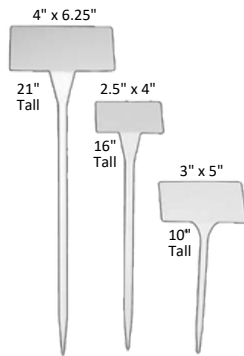
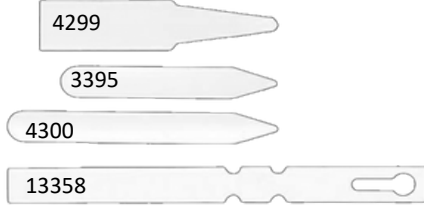

ITEM	DESCRIPTION	PRICE
4299	4-1/2" x 1" (1,000/roll-perforated)	\$24.50
13358	7" x 5/8" loop tag (1,000/roll-perforated)	\$35.95
3395	4" x 5/8" (1,000/box- loose)	\$31.95
4300	5" x 5/8" (1,000/box- loose)	\$36.00
11195	3" x 5" Angled T-sign, 10" height, 50/cs	\$35.60
11196	2-1/2" x 4" Angled T-sign, 16" height, 50/cs	\$38.95
11197	4" x 6" Angled T-sign, 20" height, 25/cs	\$39.75
13988	2 1/4" X 3 3/4" Flat T-signs, 10"height, 100/cs	\$43.95
11198	Base for all angled T-signs, 25/cs	\$54.95

## PERMANENT MARKERS

**Garden Marker:** Fast drying, waterproof pen that contains filters for maximum fade resistance. Alcohol-based ink. Xylene free.  
**Sharpie® Marker:** Fine point permanent marker.



ITEM	DESCRIPTION	PRICE
10442	Black Garden Marker	\$2.25
10197	Black Sharpie Marker 12 pk	\$19.00

## GRO-POT - WOVEN PLANTER BAG

Made with green 4.13 oz./Sq. Yd. UV stabilized woven cloth. Each pot has 2 sewn handles. Sold in eaches or bales of 100 pcs.



ITEM	DESCRIPTION	EACH	100/PACK
11528	9 Gallon, 14" x 14"	\$2.40	\$230.00
11529	12 Gallon, 15" x 15.75"	\$2.65	\$240.00
11530	15 Gallon, 16.5" x 17.75"	\$2.95	\$275.00

## FLOWER POUCHES

Green plastic with loop handle. Growing in flower pouch utilizes wall space and adds appeal.

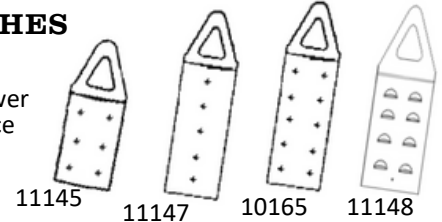

ITEM	DESCRIPTION	SIZE	VOLUME	1-249	250+
11145	6 Slit, Al's Mini	8.5 X 13.5"	1.06 gal.	\$0.75	\$0.69
11147	5 Slit, Al's	8.5 X 21.25"	1.59 gal.	\$0.75	\$0.69
10165	10 Slit, Al's	8.5 X 21.25"	1.59 gal.	\$0.75	\$0.69
11148	8 Slit, Generation 2	8 X 20"	1.06 gal.	\$0.69	\$0.65

## LIQUID CHALK

Use with T-signs. Will not wash off from rain or general watering but it can be removed with a moist paper towel. Older writing (ghosting) can be cleaned with an alcohol-based hand sanitizer.



ITEM	DESCRIPTION	PRICE
11199	Liquid Chalk Markers, 3pk-Red, Green, Blue	\$19.50

## INSECT MONITORING CARDS

Durable, long-lasting pest monitoring and trapping cards are designed to catch a variety of pests.



ITEM	DESCRIPTION	PRICE
4532	3" x 5" Yellow Sticky Cards, 48/pack	\$32.50

## CURRUGATED RETAIL FLATS *Self-Locking. No stapling required! Same size as standard 1020 flats.*

ITEM	DESCRIPTION	BUNDLE 75 PCS	BUNDLE 750 PCS	SKID 1500 PCS	LENGTH	WIDTH	DEPTH
11238	Carry Out Tray	\$44.90	\$419.00	\$798.00	21.25	10.50	2.5



## WATER-MATIC TRAYS



RESERVIOR HOLDS WATER WHILE ELEVATED OVERFLOW HOLES ENSURE THAT EXCESS WATER IS DRAINED.							DIMENSIONS	
ITEM	DESCRIPTION	PCS/CASE	1-5 CS	6+ CS	MFG CODE	DIA.	DEPTH	
11264	4.50 Rnd/Sq, 8 Ct 2x4 spaced	100	\$160.00	\$158.00	45RSWM	20.25	10.13	



# IRRIGATION

## TYPICAL DRIP SYSTEM LAYOUT

1. Pump
2. Pressure Relief Valve and/or Switch
4. Check Valve often installed on the pump or fertilizer injector
- 5 Fertilizer Injector, MIC is the best choice for most fields
7. Pressure Gauges installed on filter or fertilizer injectors
8. Screen filter for clean well, Sand Filter for surface water.
10. Mainline, often SDR26 Underground or Layflat
11. Pressure Regulators, pump throttle, and/or zone size used
12. Gate Valve, not required if using valves on drip tape connectors
13. Submain, Oval Hose or Flatube is the best choice.
14. Drip Tape Laterals.
15. Drip Tape Connectors, Numerous types available
16. Drip End Sleeves, Automatic flush valves or knotted.

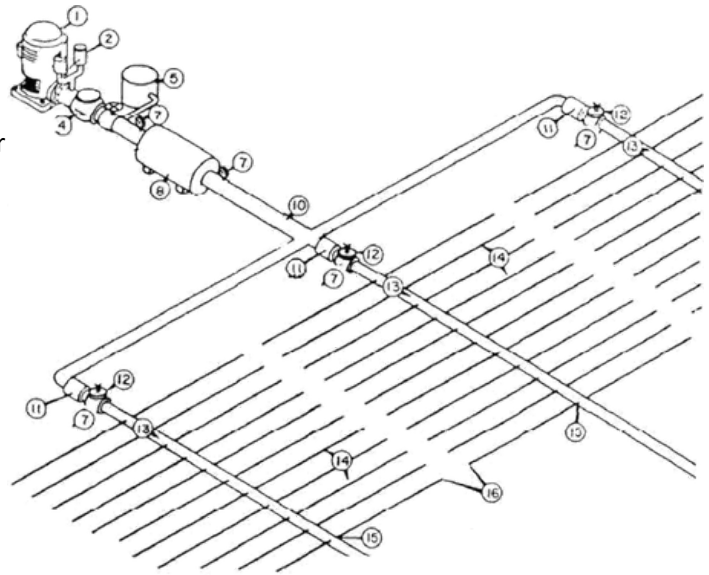

## MIXRITE PROPORTIONAL INJECTOR, 11 GPM

This fixed ratio 1:100 offers an alternative to the Chemilizer with similar specifications. This proportional fertilizer injector automatically compensates for any change in water pressure or flow to provide a constant mix at 1:100 rate. **Standard pump:** fixed ratio 1:100. **Flow Rate:** 10.2-660 gph (0.17-11 gpm) **Operating Pressure:** 6-120 psi. **Connections:** " male thread.

**Also available upon request:** 22 GPM, 45 GPM and 110 GPM units.

ITEM	DESCRIPTION	PRICE
2840	MixRite Unit (Model 556AG), 1:100	\$320.00
13797	Bypass for MixRite, FHT x MHT, this plumbing comes with three valves, filter, and check valve.	\$74.95
12694	Cart Unit: Includes MixRite, bypass, 6 gal. tank, and push cart.	\$510.00

## MixRite



## MIXRITE SERIES FERTILIZER INJECTOR

Mixrite injectors are positive displacement water driven injectors. The adjustable dosing mechanism is driven by the flow of water, which creates a vacuum and draws the chemical into the water stream at the correct dilution ratio. This ensures precise and consistent mixing of chemicals with water, without the need for expensive and complicated metering equipment. They are self-priming and do not require any electricity or external energy source, allowing for easy installation and maintenance. There is constant concentration of additive no matter what pressure and flow. The TF models have adjustable injection rates.

**TF-5 MixRite** is a low to medium flow unit used for fertilizers, pesticides and other additives for farming and irrigation. Not

intended for strong acids and alkalis or solvents. Flow rates of .88 - 22 GPM. The TF-5 has 1" MPT inlet/outlet connections. Providing higher flow rates, less friction loss and longer life than comparable models.

**TF-10 MixRite** are designed for medium water flow for fertigation, pesticide, and other in-line additives. They are intended for typical fertilizers, pesticides, and agriculture or irrigation additives. Flow rates of 2 – 45 GPM. The TF-10 has 1.5" NPT threaded connections for in-line mounting. They are not designed for strong acids, alkalis, or solvents.



ITEM	DESCRIPTION	PRICE
2810	MixRite TF-5 Injector	\$629.35
2811	MixRite TF-10 Injector	\$864.75

# IRRIGATION

## CHEMILIZER PROPORTIONAL INJECTOR, 11 GPM

The big advantage of this unit is that the chemical pump takes all the abuse of the chemicals and is easy to disassemble or replace by hand. Parts are inexpensive. Any chemicals never contaminate the water-powered motor and comes with a 2-year warranty. This proportional fertilizer injector automatically compensates for any change in water pressure or flow, providing a constant mix at a 1:100 rate.

**Max Temperature:** 100° F

**Standard pump:** fixed ratio 1:100.

**Flow Rate:** 1.2-660 gph (0.02-11 gpm)

**Operating Pressure:** 3- 85 psi.

**Connections:** 3/4" male hose thread.

ITEM	DESCRIPTION	PRICE
4924	Chemilizer Unit (Model CH9000-210), 1:100	\$298.95
12268	Bypass for Chemilizer, FHT x MHT, this plumbing comes with three valves, filter, and check valve.	\$79.50
13664	Cart Unit: Includes Chemilizer, bypass, 6 gal. tank, and push cart.	\$495.00



## DOSMATIC SUPERDOS 45 FERTILIZER INJECTORS

SuperDos operates without electricity to precisely inject liquid concentrates into a water supply line using fluid flow as the power source. SuperDos is designed with a patented internal mixing chamber that promotes homogeneous mixing while segregating harsh chemicals from critical internal components. These proportional fertilizer injectors automatically compensate for any change in water pressure or flow and provide a constant mix at the rate you set. Replacement parts available for ordering.



ITEM	DESCRIPTION	INJECTION RATIO	FLOW RATE	OPERATING PSI	PRICE
15334	SuperDos 20, 1" MPT	1:40-1:500	0.05-20 GPM	5-100	\$555.00
12608	SuperDos 30, 1" MPT, On/off handle installed	1:40-1:500	0.15-30 GPM	5-100	\$695.00
15020	SuperDos 45, 1" MPT, On/off handle installed	1:40-1:500	0.50-45 GPM	5-100	\$995.00
15335	On/off handle for Superdos 20	-	-	-	\$59.00

## DOSATRON® PROPORTIONAL INJECTOR

Dosatron® has served the horticulture industry for over 35 years and has established itself as the industry standard. Durable and reliable, these units come with common wear parts included. These water-powered proportional fertilizer injectors automatically compensate for any water pressure or flow change and provide a constant mix at the rate you set. The ratio is easy to adjust by hand with the lock to ensure your setting isn't changed accidentally—ideal for fertilizers, fungicides, acids and more.

**Maximum Temperature:** 104° F



ITEM	DESCRIPTION	INJECTION RATIO	FLOW RATE	OPERATING PSI	PRICE
13208	D25F1, 3/4" MPT (Our most precise 11 gpm unit)	FIXED 1:100	0.04-11 GPM	4.3-85	\$345.00
13209	Dosatron D14M22, 3/4" MPT	1:50 1:500	0.04-14 GPM	4.3-85	\$495.95
11836	Dosatron D45RE15, 1" MPT, On/off handle installed	1:66-1:500	0.4-20 GPM	7-70	\$665.00
14804	Dosatron D40M22, 1 1/2" MPT, On/off handle installed	1:50-1:500	2.2-40 GPM	2.2-116	\$1,060.00
14802	Cart Unit: DOS11, bypass, 6 gal. tank, and push cart.	-	-	-	\$598.00
14803	Cart Unit: DOS14, bypass, 6 gal. tank, and push cart.	-	-	-	\$725.00
13797	Bypass assembly for DOS11 and DOS14; FHT x MHT includes three valves, filter, and check valve.	-	-	-	\$74.95



# IRRIGATION



10176



12023

## TROUBLE FREE INJECTION OF FERTILIZERS

Mazzei injectors are high-efficiency, Venturi-type differential pressure injectors. A pressure difference between the inlet and the outlet of the injector creates a vacuum inside the body, which results in a suction through the suction port. The suction can then be used to inject and mix fertilizers and water treatment chemicals into the water. Mazzei injectors are trouble free because there are no moving parts, and have a long life since they are molded from chemical resistant polypropylene.

Mazzei non-proportional injectors are excellent for drip systems in fields or high tunnels, provided that fertilizer is based on rate/acre rather than PPM (constant feed). Take lb./Acre per week divided by number of applications for the week and mix it in with approx. 5 gallons of water

**Operating Instructions:** Mix and re-mix required fertilizer for irrigation cycle, start irrigation, allow pressure to stabilize in system, open the two PVC bypass valves and slowly close the brass mainline valve until the flow meter rises to the desired injection rate (GPH). Water pressure will drop 3-7 PSI dependent on flow and injection rate. When fertilizer container is empty it will draw air, but that is not harmful. Allow irrigation to operate for a while to ensure fertilizer is all out of the system.

**COMPLETE UNITS (AS PICTURED ABOVE)**  
 Injector unit with bypass mainline, 8' suction hose, (GPH) flow meter, back flow check valve, bypass valves, pressure gauge and brass gate valve to control injection rate (normally open).

ITEM	DESCRIPTION	PRICE
10176	Garden hose unit, 3/4" FHT x MHT with Model 384 Injector, no stand	\$162.35
14076	1" FPT with Model 384 Injector, no stand	\$168.55
13632	1 1/2" FPT with Model 584 Injector, with wooden stand	\$225.00
12023	2" FPT with Model 584 Injector, with wooden stand	\$249.50
15843	3" FPT with Model 1078 Injector, with wooden stand	\$498.65

SPECS. CHART				
MODEL	384	584	1078	1583 A
SIZE	1/2"	3/4"	1"	1 1/2"
MINIMUM FLOW RATES (GPM)	2	6	16	32
RECOMMENDED INJECTION (GPH)	4	8	20	40
MAX. INJECTION (GPH)	10.5	25	75	180
SIZE SUCTION LINE	1/4"	1/4"	1/2"	1/2"

INJECTORS ONLY & SUCTION LINE KIT		
ITEM	DESCRIPTION	PRICE
14789	1/2" MPT Model 384 Injector Only	\$42.00
12871	3/4" MPT Model 584 Injector Only	\$42.95
	1" MPT Model 1078 Injector Only	\$68.00
14460	1 1/2" MPT Model 1583 Injector Only	\$85.00
15805	1/4" Suction Line Kit with flow meter for 384 and 584 injectors	\$51.85
ITEM	DESCRIPTION	PRICE
15556	0-100 GPH Flow Meter, 3/8" FPT	\$53.00
16134	3-20 GPH Flow Meter, 1/4" Insert	\$42.50



12871

# IRRIGATION

## LAYFLAT - BLUE

This versatile blue layflat hose is lightweight, durable, and cost-effective, ideal for water discharge applications on main supply lines. Its resistance to rot and mildew, along with its ability to coil flat for convenient storage, make it a practical choice.

ITEM	DESCRIPTION	MAX PSI	PRICE
10813	1-1/2" x 300' Sun-Flow Blue	80	\$129.95
3643	2" x 300' Sun-Flow Blue	80	\$149.95
12169	3" x 300' Sun-Flow Blue	70	\$298.65
15328	4" x 300' Sun-Flow Blue	70	\$426.95



## LAYFLAT - RED - IRONSIDE

Ironsides is designed with a high working pressure, rendering it ideal for high-pressure irrigation systems. It exhibits resistance to kinking and twisting and can be conveniently coiled or racked even when wet.

ITEM	DESCRIPTION	MAX PSI	PRICE
15326	1-1/2" X 300' Red	150	\$325.95
5020	2" x 300' Red	150	425.00
12348	3" x 300' Red	150	\$645.25
15327	4" X 300' Red	150	\$965.00



## BLUE STRIPE® OVAL HOSE

The Blue Stripe® Oval Hose tubing is a cost-effective and lightweight option crafted from high-quality polyethylene. Great to be used for headlines and laterals on drip irrigation and micro-sprinkler systems. Lays flat when not under pressure It is suitable for punching and compatible with insert fittings and clamps.

ITEM	DESCRIPTION	MAX PSI	PRICE
4670	1" x 660' Oval Hose	42	\$138.95
4891	1 1/2" x 150' Oval Hose	21	\$53.95
3826	1 1/2" x 600' Oval Hose	21	\$157.15
3827	2" x 150' Oval Hose	21	\$63.35
10029	2" x 450' Oval Hose	21	\$164.85
11675	3" x 200' Oval Hose	21	\$189.55
14	4" x 130' Oval Hose	21	\$208.95

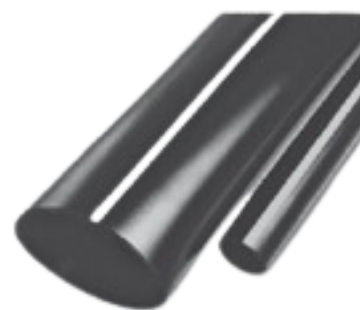

## BLACK POLY PIPE

This black utility poly tubing, characterized by its semi-rigid nature, proves beneficial for underground, well, or high-pressure applications. It is important to note that this tubing is not designed to be punctured.

ITEM	DESCRIPTION	MAX PSI	PRICE
11473	3/4" x 100'	100	\$32.75
11474	1" x 100'	100	\$41.55
10178	1" x 300'	100	\$117.75





# IRRIGATION

## ORCHARD TUBING

This lightweight polyethylene tubing is punchable and commonly serves as a lateral distribution and supply hose for online drippers, weighted drip tubes, micro sprinklers, and can also function as a header for small drip tape systems.



ITEM	DESCRIPTION	PRICE
11478	1/2" x 100' Orchard Tubing	\$22.95
11479	1/2" x 500' Orchard Tubing	\$52.95
10281	1/2" x 1000' Orchard Tubing	\$95.00
11481	3/4" x 100' Orchard Tubing	\$27.95
4508	3/4" x 500' Orchard Tubing	\$71.00
1431	1" x 100' Orchard Tubing	\$33.95
11482	1" x 250' Orchard Tubing	\$73.00
12476	3/4" x 500' WHITE Orchard Tube	\$108.00
11483	1/2" x 500' WHITE Orchard Tube	\$76.00
11480	Plastic Stake to secure 1/2" tubing	\$0.25
14407	Plastic Stake for securing 1/2" Plants Pride	\$0.15

## BLUELINE® PC PRESSURE COMPENSATING DRIPLINE

18MM (1/2") Orchard Tubing with Built-In Emitters

BlueLine™ PC is a tubing system that features a built-in emitter welded to the inside wall of the tubing, providing constant discharge over a pressure range of 15-60 PSI. This one-piece construction eliminates the need for hole punching and handling damage, reduces installation costs. It can be used in orchards, vineyards, nurseries, over containers, and buried in fields for subsurface applications.

**Stock Flow:** 0.53 GPH per emitter.



ITEM	DESCRIPTION	EMITTER SPACING	PRICE
11484	18 MM (1/2") x 1000'	12" spacing	\$158.95
11485	18 MM (1/2") x 1000'	18" spacing	\$157.95
11486	18 MM (1/2") x 1000'	24" spacing	\$147.25
11487	18 MM (1/2") x 1000'	30" spacing	\$143.95
11488	18 MM (1/2") x 1000'	36" spacing	\$132.95
11480	Plastic Stake to secure tubing		\$0.25

## ORCHARD TUBING FITTINGS

Fittings for 1/2" Orchard Tubing & 18MM PC

ITEM	DESCRIPTION	PRICE
11344	Coupling, 600s Loc	\$0.60
11347	Tee, 600s Loc	\$1.72
11343	0.40" Barb x 600s Loc with Valve	\$1.75
11345	Coupling, 600s Loc with Valve	\$1.89
10638	0.40" Barb x 600s Loc	\$0.69
11346	90° Ell, 600s Loc	\$1.25
11352	Auto-Flush x 600s Loc	\$1.95
11348	Layflat x 600s Loc	\$1.35
11349	Hose Adapter, FHT x 600s Loc	\$1.30
11351	1/2" MPT x 600s Loc	\$0.65
11350	Hose Adapter, MHT x 600s	\$0.75

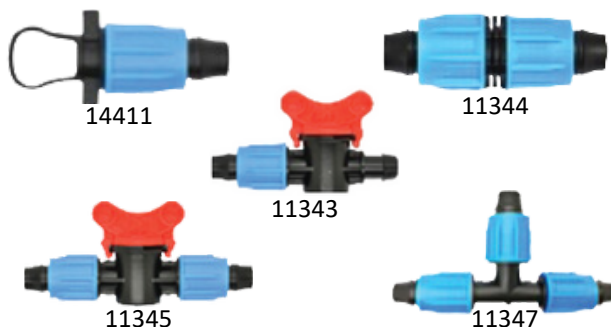

# IRRIGATION

## FLOW CONTROL PRESSURE COMPENSATING DRIP IRRIGATION TAPE

Toro Aqua-Traxx Flow Control gives you uniform output regardless of pressure changes caused by hilly terrain and long runs. Control how much water your plants receive by increasing or decreasing the operating pressure, 10-25 PSI. For uniform output you need 8-10 PSI at the highest point of the field. Multiple laser slit outlet reduces startup clogging & impedes root intrusion. 150 mesh filtration required.



ITEM	MFG CODE	DESCRIPTION	PRICE
<b>FLOW CONTROL .45 GPM/100' 12" SPACING</b>			
12008	APC08	8 MIL 7500'	\$198.00
10174	APC10	10 MIL 6000'	\$203.00
<b>FLOW CONTROL 0.34 GPM/100' 12" SPACING</b>			
12405	APC081	8 MIL 7500'	\$198.00
12058	APC101	10 MIL 6000'	\$203.00
<b>FLOW CONTROL 0.22 GPM/100' 12" SPACING</b>			
15329	APC081222	8 MIL 7500'	\$198.00
<b>FLOW CONTROL 0.22 GPM/100' 12" SPACING</b>			
12408	APC101222	10 MIL 6000'	\$203.00
<b>FLOW CONTROL 0.67 GPM/100' 6" SPACING</b>			
12572	APC080667	8 MIL 7500'	\$198.00



ITEM	FLOW RATE PER 100'	DESCRIPTION	1-15	16+
<b>6" SPACING</b>				
14492	.53gpm	8 mil 6561'	\$129.00	\$125.00
<b>8" SPACING</b>				
14493	.40gpm	8 mil 6561'	\$129.00	\$125.00
14136	.53gpm	8 mil 6561'	\$129.00	\$125.00

## CHAPIN™ DELUXE DRIP TAPE



Exclusive filtration channel keeps the debris away from the flow path and allows it to purge by flushing, ensuring high performance and extends the life of the tape. High quality polyethylene film ensures round sides providing higher resistance to field abrasion. Longer flow path ensures true drip flow.

## DRIP IRRIGATION TAPE



ITEM	FLOW RATE PER 100'	DESCRIPTION	1-15	16+
<b>4" SPACING</b>				
11782	1.34gpm	8 mil 7500'	\$173.00	\$169.00
<b>6" SPACING</b>				
3644	.67gpm	8 mil 7500'	\$176.00	\$169.00
<b>8" SPACING</b>				
13152	.34gpm	8 mil 7000'	\$179.00	\$169.00
4960	.50gpm	8 mil 7500'	\$176.00	\$169.00
13694	.67gpm	8 mil 7500'	\$189.95	\$179.50
<b>12" SPACING</b>				
12404	.22gpm	6 mil 10,000'	\$199.00	\$189.00
10012	.45gpm	6 mil 10,000'	\$195.00	\$189.00
4956	.22gpm	8 mil 7500'	\$176.00	\$169.00
2987	.34gpm	8 mil 7500'	\$176.00	\$169.00
2986	.45gpm	8 mil 7500'	\$169.00	\$166.00
3925	.34gpm	10 mil 6000'	\$182.00	\$175.00
15436	.45gpm	10 mil 6000'	\$182.00	\$175.00
10432	.45gpm	15 mil 4000'	\$185.00	\$175.00
<b>16" SPACING</b>				
12401	.17gpm	6 MIL 10,000'	\$199.00	\$189.00
12400	.25gpm	8 MIL 7500'	\$175.00	\$172.00
<b>18" SPACING</b>				
2985	.38gpm	10 mil 6000'	\$182.00	\$175.00
<b>24" SPACING</b>				
15743	.28gpm	10 mil 6000'	\$185.00	\$174.00

ITEM	FLOW RATE PER 100'	DESCRIPTION	1-15	16+
<b>12" SPACING</b>				
11865	.45gpm	8 mil 7500'	\$169.75	\$163.50
12396	.45gpm	10 mil 3000'	\$109.95	
2891	.22gpm	15 mil 4000'	\$184.95	\$175.00
<b>4" SPACING</b>				
13720	1gpm	10 mil 3000'	\$112.95	

Prices are subject to change without notice. Kindly contact us at (508) 273-7358 to verify pricing.



# IRRIGATION



2988



3598



3922



5003



3828



3829



2993



2994



3926



14390

## DRIP TAPE FITTINGS

ITEM	MFG CODE	DESCRIPTION	PRICE
BARB X TAPE LOC ADAPTER - NO VALVE			
2988	DTF250B	0.25" BARB	\$0.45
2989	DTF400B	0.40" BARB	\$0.45
BARB X TAPE LOC ADAPTER WITH VALVE			
3598	DTF250BV	0.25" BARB	\$1.59
4089	DTF400BV	0.42" BARB FLAT HANDLE	\$1.65
3922	DTF425BV	0.425" BARB YELLOW/BLUE HANDLE	\$1.50
DRIP TAPE END PIECES			
2991	DTFCAP	DRIP TAPE END SLEEVE	\$0.12
5003	DTFEND	TAPE LOC END PLUG WITH RING	\$0.52
TAPE LOC PIECES			
2992	DTFCPT	TAPE LOC COUPLING	\$0.55
10821	DTFCPTBV	TAPE LOC COUPLING WITH VALVE	\$1.60
3928	DTFELL	TAPE LOC ELL	\$1.80
12388	DTFFCH	TAPE LOC X AUTOMATIC FLUSH END	\$1.70
3828	DTFFHC	TAPE LOC X LAYFLAT ADAPTER NO VALVE	\$1.10
3830	DTFHEX	INSTALLATION TOOL FOR ITEM 3828 ABOVE	\$5.79
3829	DTFFHCBV	TAPE LOC X LAYFLAT ADAPTER WITH VALVE	\$1.85
2993	DTFFHS	TAPE LOC X FEMALE HOSE SWIVEL	\$1.40
2994	DTFMA	1/2" MPT TAPE LOC X MALE THREAD ADAPTER	\$0.83
2995	DTFMHT	MHT TAPE LOC X MALE THREAD ADAPTER	\$0.73
3926	DTFTEE	TAPE LOC TEE	\$1.40
10806	DTF400PIAG	.40" BARB X 1/4" FIPT GAUGE ADAPTER	\$2.20
13709	DTF400PIA	.40" BARB X 1/2" SOC ADAPTER	\$0.80

# IRRIGATION

## DRIP TAPE FITTINGS

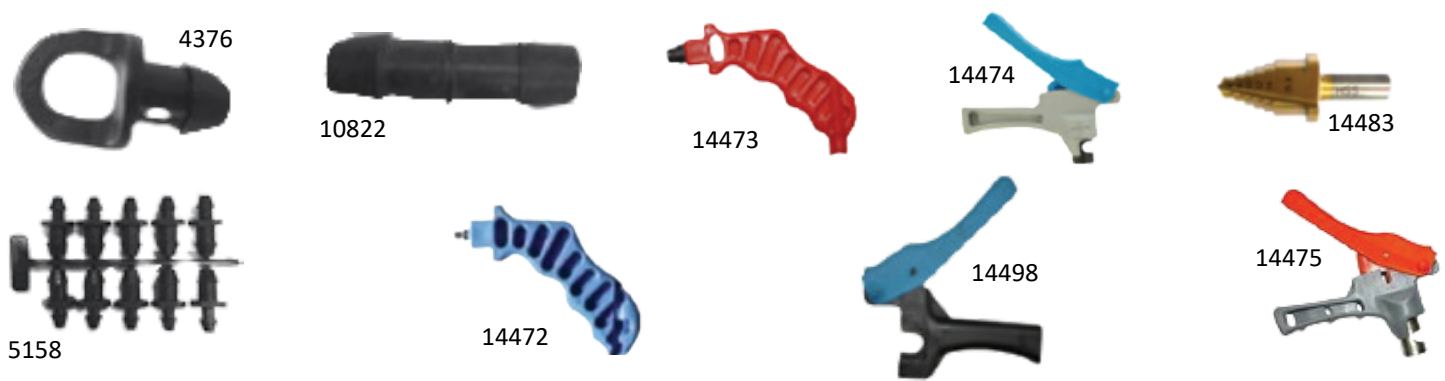

ITEM	MFG CODE	DESCRIPTION	PRICE
<b>MISTAKE &amp; GOOF PLUGS</b>			
4376	DTFMP400	MISTAKE PLUGS FOR .420" HOLES - EACH	\$0.35
5158	OTFMP1	GOOF PLUGS FOR 1/8" TO 1/4" HOLES - 10 PACK	\$0.60
<b>BARB TO BARB COUPLINGS</b>			
10822	TB-250	1/4" BARB TO BARB COUPLINGS	\$0.27
10823	TB-400	3/8" BARB TO BARB COUPLINGS	\$0.39
<b>PUNCHES FOR OVAL HOSE &amp; TUBING</b>			
3927	DTFACT400	SERRATED INSERTION PUNCH FOR 2989 & 4089	\$37.95
10691	DTFAP02	EJECTOR PUNCH: DRIPPERS 1/8" & 3/16" BARBS	\$10.95
10837	DTFAPT03	EJECTOR PUNCH: 3MM TIP	\$10.95
4961	DTFAP07	EJECTOR PUNCH: FITTINGS WITH .4"/.42"/.425" BARBS	\$10.95
10177	DTFDP400S	RED DELUXE SERRATED PUNCH FOR .4" OR .41" BARBS	\$37.75
14472	SP0103	PUNCH TOOL FOR OVAL HOSE, 0.25"	\$10.00
14498	SP250	PUNCH TOOL, 0.25" FOR 1/2 - 3/4 ORCHARD TUBE	\$28.00
14473	SP0108	PUNCH TOOL FOR OVAL HOSE, 0.4" & 0.42"	\$10.00
14474	PF0215	PUNCH TOOL FOR LAYFLAT, 15MM	\$15.95
10824	DTFFHP2	LARGE PUNCH TOOL FOR LAYFLAT, 16MM	\$66.95
14475	PF0217	PUNCH TOOL FOR LAYFLAT, 17MM	\$15.95
14483	SP0616	DRILL BIT, MULTI-SIZE	\$18.95



# IRRIGATION

## INSERT TEE



ITEM	SIZE	PRICE
11071	½"	\$1.95
11072	¾"	\$1.99
11073	1"	\$2.30
11074	1½"	\$3.80
4947	2"	\$6.25
12245	3"	\$28.00

## INSERT TEE REDUCING



ITEM	SIZE	PRICE
11083	¾ x ½"	\$1.69
10828	1 x ¾"	\$1.89
11084	1½ x ¾"	\$3.95
11085	1½ x 1"	\$3.95
11086	2 x 1"	\$4.95
1425	2 x ¾"	\$8.00

## TEE, INSERT X FPT

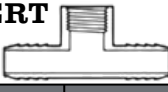

ITEM	SIZE	PRICE
11100	½"	\$2.30
11101	¾"	\$2.85
11102	1"	\$3.00
11103	1½"	\$7.00
11104	2"	\$7.65

## TEE, INSERT X FPT, REDUCING



ITEM	SIZE	PRICE
11124	¾ x ½"	\$2.30
11125	1 x ¾"	\$3.00
4950	1½ x ¾"	\$6.65
11126	1½ x 1"	\$6.65
4949	2 x ¾"	\$6.95
11127	2 x 1"	\$7.50
11833	2 x 1 1/2"	\$7.65

## INSERT CROSS

ITEM	SIZE	PRICE
10829	1"	\$5.65
15907	1/2"	\$4.00

## TEE, INSERT X MPT

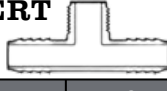

ITEM	SIZE	PRICE
11119	½"	\$2.85
11120	¾"	\$3.35
11121	1"	\$4.00
11122	1½"	\$5.40
11123	2"	\$7.60

## INSERT COUPLING



ITEM	SIZE	PRICE
11075	½"	\$0.75
11076	¾"	\$1.20
10682	1"	\$1.20
10812	1½"	\$1.85
10018	2"	\$2.95

## INSERT PLUG

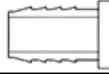

ITEM	SIZE	PRICE
11087	½"	\$1.85
11088	¾"	\$1.85
4767	1"	\$1.95
11089	1½"	\$2.55
10020	2"	\$4.20
33	3"	\$17.95

## 90° ELL, INSERT



ITEM	SIZE	PRICE
11105	½"	\$1.90
11106	¾"	\$1.80
11107	1"	\$1.65
11108	1½"	\$1.95
4948	2"	\$3.50
21	3"	\$21.50

## 90° ELL, INSERT X FPT



ITEM	SIZE	PRICE
11109	½"	\$1.95
11110	¾"	\$2.00
11111	1"	\$2.45
11112	1½"	\$3.80
11113	2"	\$5.55

## 90° ELL, INSERT X MPT

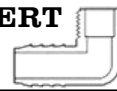

ITEM	SIZE	PRICE
11114	½"	\$2.30
11115	¾"	\$2.80
11116	1"	\$3.80
11112	1½"	\$4.45
11118	2"	\$8.00

## FPT X INSERT ADAPTER

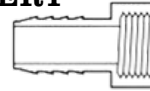

ITEM	SIZE	PRICE
11077	½"	\$2.95
10833	¾"	\$3.95
10832	1"	\$4.30
11078	1¼"	\$4.75
11079	1½"	\$6.00
11080	2"	\$6.50

## MPT X INSERT ADAPTER

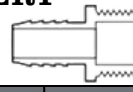

ITEM	SIZE	PRICE
11090	½"	\$1.10
10835	¾"	\$1.25
10834	1"	\$1.35
11091	1¼"	\$1.75
11092	1½"	\$1.75
11093	2"	\$2.95
666	3"	\$13.95

## MPT X INSERT ADAPTER, REDUCING



ITEM	SIZE	PRICE
11128	½ x ¾"	\$2.50
11129	¾ x ½"	\$2.50
11130	¾ x 1"	\$2.60
11131	1 x ¾"	\$2.70
11132	1 x 1½"	\$4.20
11133	1½ x 1"	\$3.65
11134	1½ x 2"	\$5.95
10405	2 x 1½"	\$5.50
12243	2 x 3"	\$18.90

## SCH80 NIPPLES, MPT X MPT



ITEM	SIZE	PRICE
11135	½" x Close	\$1.20
11136	½" x 3"	\$1.30
4849	¾" x Close	\$1.35
11137	¾" x 6"	\$1.95
11138	1" x Close	\$1.95
14039	1" x 6"	\$2.39
11140	1½" x Close	\$2.25
11141	2" x Close	\$2.75

## SS HOSE CLAMPS

All Stainless steel - won't rust



ITEM	SIZE	EA
14037	½"	\$0.88
14038	¾"	\$0.89
14036	1"	\$0.94
14035	1½"	\$0.94
10651	2"	\$1.00
12616	3"	\$1.60
14213	4"	\$1.60

## REDUCING COUPLING INSERT

ITEM	SIZE	PRICE
15605	3/4 x 1/2"	\$1.35
10831	3/4 x 1"	\$1.70
12199	1 x 1 1/2"	\$3.20
11859	1 1/2 x 2"	\$3.80
99	2 x 3"	\$24.25

**MANY OTHER FITTINGS IN STOCK. PLEASE CALL AND ASK**

# IRRIGATION

## SOCKET TEE

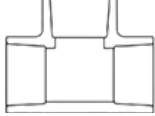

ITEM	SIZE	PRICE
11354	½"	\$0.95
11355	¾"	\$1.05
11356	1"	\$1.59
14537	1 1/4"	\$4.49
13538	1 1/2"	\$2.59
12591	2"	\$3.59

## FPT TEE

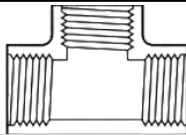

ITEM	SIZE	PRICE
11357	½"	\$3.29
11358	¾"	\$3.95
11359	1"	\$4.59

## SOCKET ELL

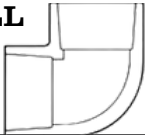

ITEM	SIZE	PRICE
11360	½"	\$0.79
11361	¾"	\$0.89
11362	1"	\$1.19

## ELL, SOCKET X FPT

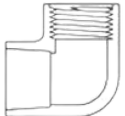

ITEM	SIZE	PRICE
11363	½"	\$1.19
11364	¾"	\$0.95
14565	1"	\$5.18
14567	2"	\$13.84

## FPT, ELL

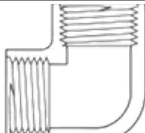

ITEM	SIZE	PRICE
11366	½"	\$1.35
11367	¾"	\$2.35
11368	1"	\$4.25
14570	1 1/2"	\$6.45
14571	2"	\$8.15

## SPIG X FPT ADP.

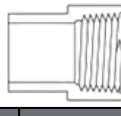

ITEM	SIZE	PRICE
11369	½"	\$1.05
11370	¾"	\$1.10
11371	1"	\$1.50

## SOCKET COUPLING

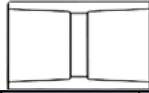

ITEM	SIZE	PRICE
11372	½"	\$0.49
4904	¾"	\$0.75
11373	1"	\$0.95
14594	1 1/2"	\$1.69
14595	2"	\$2.25

## FPT COUPLING

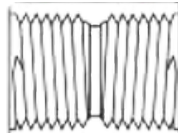

ITEM	SIZE	PRICE
11374	½"	\$1.55
11375	¾"	\$1.85
11376	1"	\$1.95
13861	2"	\$4.25

## FPT X SOCKET ADP.

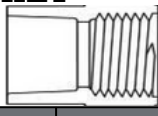

ITEM	SIZE	PRICE
11377	½"	\$0.89
11378	¾"	\$1.19
11379	1"	\$1.19
14596	1 - 1/2"	\$1.80
12022	2"	\$1.95

## MPT X SOCKET ADP.

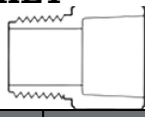

ITEM	SIZE	PRICE
14597	½"	\$0.70
11381	¾"	\$0.80
11382	1"	\$1.19
11380	1 - 1/2"	\$1.69
14598	2"	\$1.95

## MPT X SOCKET ADP., REDUCING

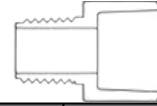

ITEM	SIZE	PRICE
11383	½ x ¾"	\$1.39
11384	¾ x ½"	\$1.29
11385	¾ x 1"	\$1.85
4902	1 x ¾"	\$3.69
14599	1 1/2 x 2"	\$4.59
14600	2 x 1 1/2"	\$4.85

## SPIG X INSERT ADP.

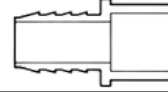

ITEM	SIZE	PRICE
11386	¾"	\$2.99
11387	1"	\$2.99

## BUSHING, SPIG X SOC

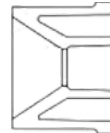

ITEM	SIZE	PRICE
11388	¾ x ½"	\$0.90
11389	1 x ½"	\$1.19
11390	1 x ¾"	\$1.19

## BUSHING, SPIG X FPT

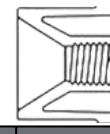

ITEM	SIZE	PRICE
11392	½ x ¼"	\$1.70
11393	¾ x ¼"	\$1.65
4905	¾ x ½"	\$1.65
11394	1 x ½"	\$1.85
11395	1 x ¾"	\$1.85

## PVC PIPE CEMENT

Lo-VOC, medium bodied, clear cement for use on all schedules and classes of PVC pipe and fittings up to 6" diameter.



ITEM	SIZE	PRICE
10842	½ Pint	\$5.95
10799	1 Pint	\$11.25

## BUSHING, MPT X FPT

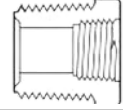

ITEM	SIZE	PRICE
11396	½ x ¼"	\$3.40
11397	¾ x ¼"	\$1.95
11398	¾ x ½"	\$1.95
11399	1 x ½"	\$2.39
11400	1 x ¾"	\$2.40
11401	1¼ x 1"	\$2.95
11402	1½ x ¾"	\$3.85
12609	1½ x 1"	\$3.85
11404	1½ x 1¼"	\$3.85
11405	2 x 1"	\$3.95

## SOCKET CAP

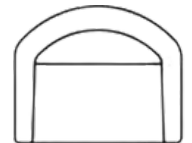

ITEM	SIZE	PRICE
11406	½"	\$0.69
11407	¾"	\$0.79
11408	1"	\$0.99

## PRESSURE GAUGES

2" Face. ¼" MPT base

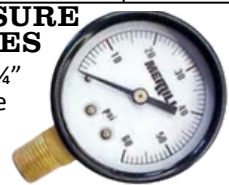

ITEM	PSI	PRICE
11143		
10805	30	\$4.50
11143	60	\$4.50
14040	100	\$4.50
11144	200	\$4.50
LIQUID FILLED 2.5" FACE		
14211	200	\$9.95
4032	300	\$9.95

## TEFLON THREAD TAPE

PTFE tape, 3.5 mil thickness.



ITEM	SIZE	PRICE
11413	½" x 520"	EA. \$0.69
		10+\$0.65
11414	1" x 520"	EA. \$1.39
		10+\$1.35



# IRRIGATION

## PVC BALL VALVE



ITEM	SIZE	BAG 10
<b>THREADED</b>		
11417	½" FPT	\$2.00
10826	¾" FPT	\$2.95
10827	1" FPT	\$4.25
11418	1 ¼" FPT	\$5.25
10684	1½" FPT	\$6.95
10817	2" FPT	\$9.85
<b>SOCKET</b>		
11419	½" SOC	\$2.75
11420	¾" SOC	\$3.95
11421	1" SOC	\$4.95

## PVC UNION BALL VALVES



ITEM	SIZE	PRICE
11422	½" SOC	\$7.25
11423	¾" SOC	\$9.25
11424	1" SOC	\$12.95

## PVC UNIONS

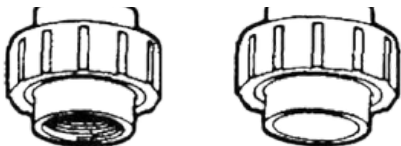

ITEM	SIZE	EA
<b>THREADED</b>		
11094	½" FPT	\$3.25
11095	¾" FPT	\$4.65
11096	1" FPT	\$4.95
10683	1½" FPT	\$9.75
14813	2" FPT	\$13.65
<b>SOCKET</b>		
11097	½" SOC	\$2.95
11098	¾" SOC	\$3.50
11099	1" SOC	\$4.35

## BRASS SWING CHECK VALVE

Full flow, FPT x FPT



ITEM	SIZE	PRICE
11434	½" FPT	\$9.70
11435	¾" FPT	\$10.95
11436	1" FPT	\$14.15
11437	1 ¼" FPT	\$21.75
11438	1½" FPT	\$28.95
11439	2" FPT	\$39.65

## BRASS BALL VALVES, FPT



ITEM	SIZE	PRICE
11425	½" FPT	\$7.95
11426	¾" FPT	\$11.55
11427	1" FPT	\$16.95
11428	1¼" FPT	\$25.75
11429	1½" FPT	\$33.95
11430	2" FPT	\$44.85

## RATCHET PVC PIPE CUTTER

Cuts up to 1" PVC pipe.



ITEM	SIZE	PRICE
15052	PVC Cutter	\$19.50

## PLASTIC PIPE & POLY TUBING CUTTER

Cuts up to 1" pipe or tubing. Fast, clean cutting.



ITEM	SIZE	PRICE
11415	Tubing Cutter	\$12.50

## BRASS BALL VALVES, INSERT



ITEM	SIZE	PRICE
11431	¾"	\$25.95
11432	1"	\$28.85
11433	1¼"	\$43.95

## CLEAR VINYL TUBING

Can be used for replacement suction hose on injectors.

15% Discount on 100' rolls

ITEM	SIZE	MAX PSI	PRICE
11142	¼"	55	\$0.23
3919	⅜"	45	\$0.26
15835	1/2"	30	\$0.65
15836	1"	25	\$0.91

## FROST-PROOF HYDRANTS

High capacity, top-quality blue hydrants from Boshart Industries. Bury Depth: 3'. MHT outlet x FPT inlet (listed below as size.)

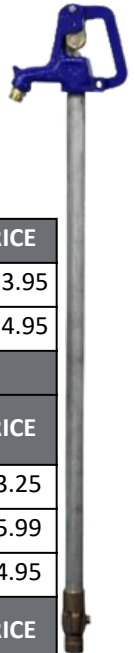

ITEM	SIZE	PRICE
11442	¾"	\$113.95
11443	1"	\$114.95

## BRASS HYDRANT FITTINGS

ITEM	TEE, INSERT X MPT	PRICE
11444	¾"	\$13.25
11445	1"	\$15.99
11446	1" x ¾"	\$14.95

ITEM	ELL, INSERT X MPT	PRICE
11448	¾"	\$9.95
11449	1"	\$13.50
11450	1" x ¾"	\$13.95

## BRASS BOILER DRAIN VALVES

MPT inlet x Male Garden Hose Thread outlet



ITEM	SIZE	PRICE
11441	¾" MPT Base	\$8.65
11440	½" MPT Base	\$6.95

# IRRIGATION

## CAMLOCK-IRRIGATION

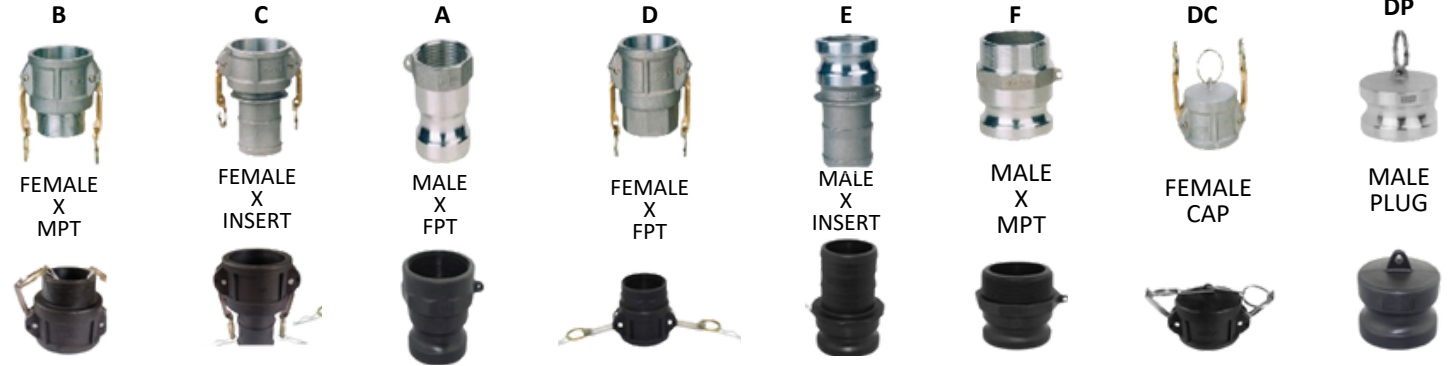

### MALE X FPT - PART A

ITEM	SIZE	PRICE
14414	1-1/2" Aluminum	\$4.35
11826	2" Aluminum	\$4.95
14204	3" Aluminum	\$9.95
12139	1-1/2" Poly	\$4.00
12025	2" Poly	\$4.40
14422	3" Poly	\$7.10

### FEMALE X MPT - PART B

ITEM	SIZE	PRICE
14415	1-1/2" Aluminum	\$4.30
11971	2" Aluminum	\$10.59
14416	3" Aluminum	\$15.75
14423	1-1/2" Poly	\$8.50
12019	2" Poly	\$9.50
14424	3" Poly	\$15.80

### FEMALE X INSERT - PART C

ITEM	SIZE	PRICE
12575	1-1/2" Aluminum	\$9.95
5018	2" Aluminum	\$10.95
13819	3" Aluminum	\$16.25
14425	1-1/2" Poly	\$7.75
3831	2" Poly	\$9.50
3833	3" Poly	\$16.00

### FEMALE X FPT - PART D

ITEM	SIZE	PRICE
14417	1-1/2" Aluminum	\$8.80
14418	2" Aluminum	\$13.55
14419	3" Aluminum	\$15.55
14426	1-1/2" Poly	\$8.80
11825	2" Poly	\$10.79
12347	3" Poly	\$16.50

### MALE X INSERT - PART E

ITEM	SIZE	PRICE
12574	1-1/2" Aluminum	\$4.50
5019	2" Aluminum	\$5.75
13820	3" Aluminum	\$11.00
14429	1-1/2" Poly	\$3.00
3832	2" Poly	\$4.50
3834	3" Poly	\$8.00

### MALE X MPT - PART F

ITEM	SIZE	PRICE
12625	1-1/2" Aluminum	\$4.90
10814	2" Aluminum	\$5.59
14421	3" Aluminum	\$10.60
14430	1-1/2" Poly	\$3.10
12020	2" Poly	\$4.50
14431	3" Poly	\$6.85

### FEMALE CAP - PART DC

ITEM	SIZE	PRICE
14437	1-1/2" Aluminum	\$6.95
13156	2" Aluminum	\$10.95
14439	3" Aluminum	\$12.60
14442	1-1/2" Poly	\$8.10
14445	2" Poly	\$10.00
14446	3" Poly	\$14.70

### MALE PLUG - PART DP

ITEM	SIZE	PRICE
14438	1-1/2" Aluminum	\$2.95
12432	2" Aluminum	\$3.95
14440	3" Aluminum	\$6.00
14447	1-1/2" Poly	\$2.50
13227	2" Poly	\$3.75
12242	3" Poly	\$7.50

### CAMLOCK GASKETS

ITEM	SIZE	PRICE
12577	1-1/2"	\$1.25
13157	2"	\$1.25
15559	3"	\$1.46
15560	4"	\$1.46





# IRRIGATION

## BATTERY OPERATED CONTROLLERS

Commercial grade, waterproof, constructed of high impact plastic, these controllers operate on two AA alkaline batteries for up to 3 years. No AC power source required! Fully featured automatic, semi-automatic, and manual operation easily programmed with five buttons and an easy-to-read LCD display. Connection: 2 wire.



### SINGLE STATION WITH VALVE

ITEM	DESCRIPTION	PRICE
11453	Controller with 3/4" valve	\$109.55
11454	Controller with 1" valve	\$114.95
15764	Propagation Controller with 1" valve	\$119.95
11456	Controller with 1 1/2" valve	\$172.95
11457	Controller with 2" valve	\$189.45

### MULTIPLE STATION

ITEM	DESCRIPTION	PRICE
11458	Four Station Controller with waterproof cables	\$112.95
11459	Six Station Controller with waterproof cables	\$117.95

## ELECTRIC SOLENOID VALVE 24 VAC

Requires 120 volt AC input and has 24 VAC output for valves, has one 9 volt battery for backup and programming. Fully featured automatic, semiautomatic, and manual operation, easily programmed with four buttons and an easy-to-read LCD display. 24 VAC valves sold separately.



ITEM	DESCRIPTION	FLOW RANGE	PRICE
10457	X" AC Solenoid Valve, 24V	0.1-28 GPM	\$24.95
11468	1" AC Solenoid Valve, 24V	0.2-35 GPM	\$24.95
11469	1 1/2" AC Solenoid Valve, 24V	20-140 GPM	\$87.85
11470	2" AC Solenoid Valve, 24V	30-170 GPM	\$91.45

## BATTERY OPERATED VALVES, 2 WIRE DC

Heavy-duty plastic valves with DC latching solenoid for the above controllers. They feature a manual flow control valve and are normally closed. Connections are all FPT x FPT. Operating Pressure: 10 – 150 PSI.



ITEM	DESCRIPTION	FLOW RANGE	PRICE
11460	3/4" DC Solenoid Valve	0.1 – 28 GPM	\$43.95
11461	1" DC Solenoid Valve	0.2 – 35 GPM	\$44.95
11462	1 1/2" DC Solenoid Valve	20 – 135 GPM	\$105.55
11463	2" DC Solenoid Valve	30 – 160 GPM	\$105.95

## INDOOR 6 STATION AC CONTROLLERS

Requires 120 volt AC input and has 24 VAC output for valves, has one 9 volt battery for backup and programming. Fully featured automatic, semiautomatic, and manual operation, easily programmed with four buttons and an easy-to-read LCD display. 24 VAC valves sold separately.



ITEM	DESCRIPTION	PRICE
14831	Galcon Six Station AC Controller	\$103.95
15765	Six Station AC Propagation Controller	\$159.95

## TORO® EVOLUTION® AG SERIES CONTROLLER

The EVOLUTION® AG, built on the award-winning Evolution platform, allows for modular expansion, fertilizer injection, pulse irrigation, propagation, and misting schedules, along with the freedom to program valves to your specific needs from 1 second to 24 hours. Full Toro Support Features a lockable, weather-resistant case. Can run three separate programs.



Adjust schedules +/- by percentage. Schedule Options: Weekly, Interval, or Looping. Automatic or manual operation. (not in stock): Wireless soil sensor, wireless weather sensor, wireless handheld remote, wireless auxiliary relay, Smart Connect® plug-in receiver.

ITEM	DESCRIPTION	PRICE
11464	Four Station Evolution Controller	\$262.15
11465	4 Station Module (to add-to controller)	\$39.95
11466	12 Station Module (to add-to controller)	\$123.45

# IRRIGATION

## BATTERY GARDEN HOSE CONTROLLER

These garden hose controllers have FHT x MHT and are battery-operated. Batteries are not included.

**11471** is easy to program with four buttons and an easy-to-read LCD. Operates on one 9V battery. Automatic and manual operation.

**14832** is easy to program via the DIG BTT free app for Android or iPhone from up to 50' away. The button is to open/close without a smart device manually. Operates on two AA batteries.



14871

14832

ITEM	DESCRIPTION	PRICE
11471	B09D Digital, Max 5.2 GPM & 80 PSI	\$42.95
14832	BOHE-BT Bluetooth, Max 6 GPM & 120 PSI	\$52.50

## PRESSURE REGULATORS

Pre-set, maintain constant pressure, and automatically adjusts to flow conditions. NOTE: If water is shut off or the flow drops below the GPM flow range, these regulators will not regulate the flow.



13353



4845



3020



12617



10809

ITEM	THREAD	SIZE	PSI	GPM RANGE	PRICE
11451	FHT X MHT	3/4"	15 (GARDEN HOSE)	0.1-8	\$9.50
14126	FHT X MHT	3/4"	20 (GARDEN HOSE)	0.5-15	\$8.90
4845	FPT	3/4"	15	0.5-15	\$9.50
3020	FPT	3/4"	20	0.5-15	\$9.50
13353	FPT	3/4"	35	0.5-15	\$9.50
12617	FPT	1"	15	2-20	\$13.95
10809	FPT	1"	20	2-20	\$13.95
4447	FPT	1"	25	2-20	\$13.95
11452	FPT	1"	35	2-20	\$13.95
15330	MPT	1 1/2"	15	7-35	\$35.00
10689	MPT	1 1/2"	20	7-35	\$41.50
10406	MPT	1 1/2"	35	7-35	\$41.50
12586	FPT	2"	15	20-100	\$110.00
15331	FPT	2"	20	20-100	\$94.00
15332	FPT	2"	35	21-105	\$173.75

## MECHANICAL GARDEN HOSE TIMER

The Dramm® garden hose timer is simple to use, just turn the dial to desired watering time (up to 2 hours) and the timer will automatically stop the water flow at the time you set. Max flow rate: 5 GPM.



ITEM	DESCRIPTION	PRICE
10808	Mechanical Garden Hose Timer	\$16.95



# IRRIGATION

## PLASTIC SCREEN FILTERS

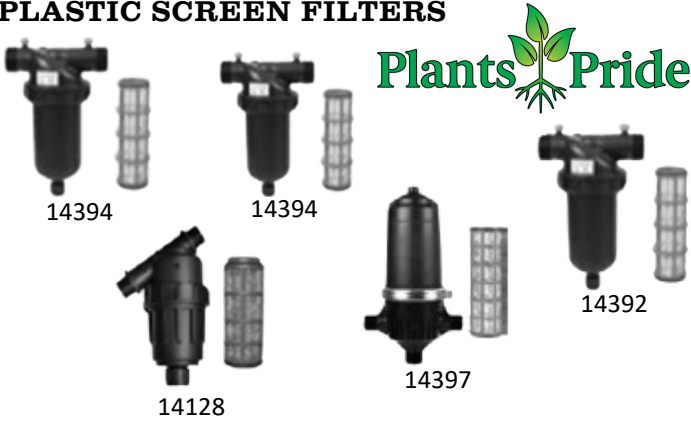

ITEM	DESCRIPTION	SIZE	CONNECTOR CONFIG	MESH STD	PRICE
10417	Plastic Screen Filter (for Garden Hose)	3/4"	FHTXMHT	155	\$13.95
14128	Plastic Screen Filter	3/4"	NPT(male)	120	\$10.50
14130	Plastic Screen Filter	1"	NPT(male)	120	\$17.16
14392	Plastic Screen Filter	1 1/2"	NPT(male)	120	\$21.75
14394	Plastic Screen Filter	2"	NPT(male) T	120	\$82.25
14138	Replacement Screen				\$2.00

## PLASTIC SPIN-CLEANER FILTERS

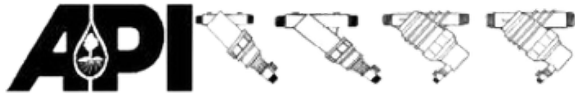

Even well water or other sources of clean water require filtration for irrigation, especially for permanent or reusable systems. Two-piece threaded housing with O-ring seal for easy maintenance. Strong, stainless steel screens. High Pressure up to 80psi. Ball valve for flushing. Repair parts available. Standard screen: 150 mesh (100 microns).

ITEM	SIZE	MAX FLOW	PRICE
10402	3/4" MPT	9 GPM	\$24.95
10403	1" MPT	18 GPM	\$25.95
10404	1 1/2" MPT	55 GPM	\$215.00
10401	2" MPT	90 GPM	\$240.00

## PLASTIC DISK FILTERS

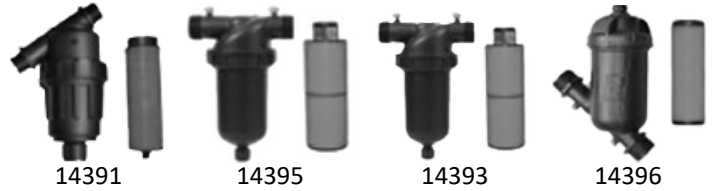

ITEM	SIZE	CONNECTOR CONFIG	MESH STD	PRICE
14391	3/4"	NPT (male)	120	\$10.50
14393	1 1/2"	NPT (male)	120	\$21.75
14395	2"	NPT (male)	120	\$189.95
14396	2"	NPT (male) SUPER Y	120	\$199.95
12078	2"	MPT (male) Toro	150	\$209.75
12576	3"	MPT (male) Toro	150	\$219.95

## LIGHTWEIGHT PLASTIC SCREEN FILTER



Lightweight stainless steel screen. Housing threads apart for easy screen removal for cleaning. **150 mesh standard.**

ITEM	DESCRIPTION	PRICE
15863	3/4" - Max 7 GPM, MPTxMPT	\$11.59
15864	1" - Max 15 GPM, MPTxMPT	\$16.85
15865	1 1/2" - Max 30 GPM, MPTxMPT	\$21.85

## AIR VALVES

These high-quality air valves are designed specifically for farm irrigation systems, ensuring optimal water flow control and pressure management. Built to withstand rugged farm environments, they provide reliable performance and easy installation for enhanced irrigation efficiency.



14450

14451

ITEM	DESCRIPTION	PRICE
14450	K Type Kinetic Air Valve, 1" BSP/NPT	\$18.00
14451	K Type Kinetic Air Valve, 2" BSP/NPT	\$38.00

# IRRIGATION

## SELF PRIMING PUMPS WITH 6.5 HP GX200 HONDA ENGINE

The model 2P5X is a popular pump in agriculture. It delivers up to 88 PSI and up to 125 GPM. Suitable for irrigating up to 2-3 acres at one time. Discharge port rotates in 90° increments.

ITEM	DESCRIPTION	PRICE
11896	Model 2P5X - 2" high pressure	\$835.50
13681	Model 2P5X - 2" high pressure complete unit with roll cage & 6 gallon gas tank (as pictured)	\$1,050.00
16135	Model 2S5X - 2" trash pump (up to 1" solids)	\$875.00
9455	Model 3S5X - 3" trash pump (up to 1.25" solids)	\$1,050.00



### Optional Accessories for add-on or can be installed on new units

ITEM	DESCRIPTION	PRICE
16136	Roll cage (for above pumps)	\$125.00
8365	6.6 gal gas tank kit (removable quick disconnect)	\$115.00
8861	Murphy low water pressure pump switchgauge	\$99.00
PPA15	Switchgauge mounting panel and connections	\$60.00
PPA1180	Engine shutoff timer, up to 6 hrs, has bypass switch	\$135.00

2P5X						
GPM	125	100	75	50	25	0
PSI	0 PSI	29 PSI	48 PSI	65 PSI	76 PSI	88 PSI
2S5X						
GPM	175	125	100	75	50	0
PSI	6 PSI	24 PSI	30 PSI	34 PSI	39 PSI	47 PSI
3S5X						
GPM	300	200	150	100	50	0
PSI	0 PSI	22 PSI	29 PSI	35 PSI	40 PSI	44 PSI

## SUPER HIGH PRESSURE PUMPS, 2 STAGE

Ideal for 150' or more elevation (up to 270').  
Cast aluminum construction with cast iron diffusers.  
High efficiency precision cast aluminum impellers. Self-priming, oil alert. 1-1/2" MPT outlet.

ITEM	DESCRIPTION	PRICE
8475	IPT 2MP5 W/ 5.5 HP GX160 Engine & roll cage	\$1,495.00
16137	Above w/ quick disconnect 6 gal gas tank	\$1,595.00
8488	IPT 2MP9 W/ 9 HP GX270 Engine & roll cage	\$1,995.00
14334	Above w/ quick disconnect 12 gal gas tank	\$2,250.00

2S5X						
GPM	175	125	100	75	50	0
PSI	6 PSI	24PSI	30PSI	34 PSI	39 PSI	47PSI
3S5X						
GPM	300	200	150	100	50	0
PSI	0PSI	22 PSI	29 PSI	35 PSI	40 PSI	44 PSI

### SELECTING A PUMP

- Start with desired operating pressure (i.e. 18 PSI).
- Add 22 PSI per 50' of rise or elevation.
- Add friction loss: see chart on page 88.
- Add filter pressure loss: approximately 7 PSI
- Example Total: 65 PSI (operating pressure @ pump).



ITEM	DESCRIPTION	PRICE
11893	Suction Line 2"	\$3.25 PER FOOT
14157	Suction Clamp 2"	\$5.25
13710	Steel Suction Strainer 2" Fine 1/8"	\$17.50
13711	Steel Suction Strainer 2" Course 3/8"	\$17.50
15967	Steel Suction Strainer 3"	\$105.00



# IRRIGATION

## WHITE SPIDER ASSEMBLIES

Multi-outlet device for PCD drippers. These four outlet assemblies are commonly used for mums and other potted plants. They have straight stakes which allows for easy removal from established plants. Use with Anti-Drain PCD drippers.



ITEM	DESCRIPTION	10 PACK	100 CASE
12479	Spider, 4 x 18" tubes	\$12.50	\$114.00
12480	Spider, 4 x 24" tubes	\$13.00	\$119.00
12481	Spider, 4 x 30" tubes	\$13.80	\$125.00
12482	Spider, 4 x 36" tubes	\$14.50	\$132.00

## SPIDER COMPONENTS

Make your spiders to water anywhere from 1 to 6 pots per dripper using 1/8" spaghetti tubing (below).

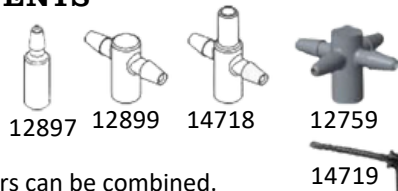

Tees, crosses, and adapters can be combined.

ITEM	DESCRIPTION	1-99	100+
12897	Single Outlet Adapter	\$0.13	\$0.11
12899	Two Outlet Tee	\$0.11	\$0.10
14718	Two Outlet Cross	\$0.13	\$0.12
12759	Four Outlet Cross	\$0.18	\$0.16
14719	Dripper Stake, Elbowed	\$0.14	\$0.13
15915	Dripper Stake, Straight	\$0.14	
16010	Four Outlet Stacking Manifold	\$0.50	

## PRESSURE COMPENSATING 0.05 GPH

Micro Flappers® elbow. You can put these on above Jain drippers to make them pressure-compensating. To do that you'll need 1.5" length of BVT0012 0.118" ID tubing each. Uniform flow regardless of pressure, elevation, and length of supply line. Operating Pressure: 15-45 PSI.

ITEM	DESCRIPTION	1-99	100+
14723	.05 GPH Emitter, 90° E11	\$0.49	\$0.45

## NATAFIM™ POT DRIPPERS

SlimLine EZ Close Assemblies combines the benefits of:

- On hand, EZ closes the shut-off of individuals baskets-prevents water and fertilizer spillage and waste
- Snag-free slim design for easy retrieval from plants at harvest - no more lost weights
- 94% flow uniformity-from the first basket to the last

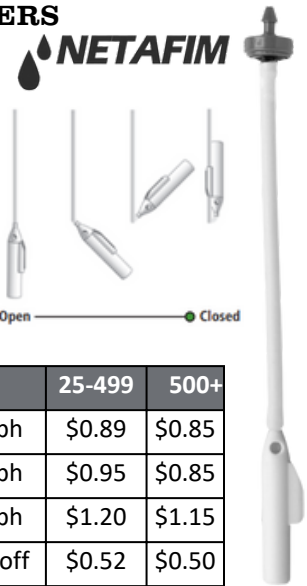

ITEM	DESCRIPTION	25-499	500+
13466	Pot Dripper, 24" tube, 1/2 gph	\$0.89	\$0.85
12910	Pot Dripper, 36" tube, 1/2 gph	\$0.95	\$0.85
4510	Pot Dripper, 48" tube, 1/2 gph	\$1.20	\$1.15
13540	Slimline Plastic Weight/Shutoff	\$0.52	\$0.50

## JAIN ON/OFF TWIST WEIGHTS

These plastic on/off twist weights come with 0.060" ID tubing. Not pressure compensating, used for fast watering. Max of 50' row lengths when using / supply line.



ITEM	DESCRIPTION	PRICE
13086	On/Off Twist Weight, 24" tube	\$1.32
14721	On/Off Twist Weight, 36" tube	\$1.39
14722	On/Off Twist Weight, 48" tube	\$1.39

# IRRIGATION

## PC ANTI-DRAIN DRIPPERS

These can be punched into orchard tubing and are used in vineyards, orchards, nurseries, and greenhouses. Anti-drain and pressure compensating. Operating Pressure: 15-60 PSI.



ITEM	DESCRIPTION	PRICE	500+
12478	Blue, 0.5 GPH w/Nipple for Spiders	\$0.27	\$0.25
10679	Gray, 1.0 GPH w/Nipple for Spiders	\$0.27	\$0.25
11846	Red, 2.1 GPH w/Nipple for Spiders	\$0.27	\$0.25
13547	WPJC Netafim Red, 0.5 GPH w/Barb	\$0.33	\$0.30
14717	WPJC Netafim Grey, 1.0 GPH w/Barb	\$0.33	\$0.30

## BARB TO BARB COUPLING



ITEM	DESCRIPTION	1-99	100+
12835	1/8" Barb Couplings	\$0.11	\$0.09
14720	3/16" Barb Couplings	\$0.11	\$0.09

## SPAGHETTI TUBING

ITEM	DESCRIPTION	DIMENSIONS	PRICE
12837	Black 1/8" x 100'	0.187 OD X 0.118" ID	\$7.50
12833	Black 1/8" x 1000'	0.196"OD X 0.126" ID	\$43.55
15750	Black 1/8" x 2500'	0.196"OD X 0.126" ID	\$97.00
14008	Black 3/16" x 100'	0.250 OD X 0.170" ID	\$8.55
10398	Black 3/16" x 1000'	0.196"OD X 0.126" ID	\$65.00
15542	White 1/8" x 1000'	0.196" OD X 0.126" ID	\$67.00

## POT SPRAY STAKES

Provides consistent flow and 160° spray pattern. Unique positioning arrow for an indicator of flow. Use 1/8" or 3/16" couplings & spaghetti tubing.



ITEM	DESCRIPTION	1-99	100+
13813	Pot Spray Stake, 6.4 GPH, Black	\$0.27	\$0.25
14724	Pot Spray Stake, 10.5 GPH, Blue	\$0.27	\$0.25
12908	Pot Spray Stake, 16.0 GPH, Green	\$0.27	\$0.25

## Plants Pride

### MICRO SPRINKLERS



ITEM	DESCRIPTION	PRICE
14454	Microsprinkler Support Stand Set with 20" Tube	\$0.95
14455	Microsprinkler Support Stand Set, 15-3/4" Tube	\$0.75
14484	Microsprinkler, Hanging, Black Nozzle - 8 gph	\$0.95
14485	Microsprinkler, Hanging, Blue Nozzle - 13.2 gph	\$0.95
14486	Microsprinkler, Hanging, Green Nozzle - 20 gph	\$0.95
14487	Microsprinkler, Hanging, Red Nozzle - 25 gph	\$0.95
14488	Microsprinkler, Upright, Black Nozzle	\$0.95
14489	Microsprinkler, Upright, Blue Nozzle	\$0.95
14490	Microsprinkler, Upright, Green Nozzle	\$0.95
14491	Microsprinkler, Upright, Red Nozzle	\$0.95

## FOGGERS

ITEM	DESCRIPTION	PRICE
14448	Fogger, 4-Way with Black Nozzle	\$0.95
14449	Fogger, 4-Way with Grey Nozzle	\$0.95

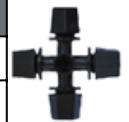



# IRRIGATION



- Seven Flow Rates (GPM): 0.88, 1.10, 1.54, 1.98, 2.42, 2.86, 3.30
- Two Water Trajectory Angles: High – 24 Degrees & Low – 15 Degrees
- Perfectly balanced sprinkler with two equal water jets - no wobble
- Robust design is closed and compact preventing insect penetration and protecting internal parts
- Excellent distribution uniformity
- Can be installed on solid sets or in removable parts
- Each unit has an individual filter for nozzle
- Color-coded for easy identification
- V protected materials are durable in all climates
- Resistant to fertilizers and chemicals



## MEGANET NOZZLES

ITEM	DESCRIPTION	FLOW
15250	Yellow Nozzle	.88 GPM
14113	Purple Nozzle	1.10 GPM
15124	Green Nozzle	1.54 GPM
7103	Blue Nozzle	1.98 GPM
14300	Brown Nozzle	2.42 GPM
3226	Orange Nozzle	2.86 GPM
14265	Red Nozzle	3.30 GPM

## MEGANET RISER ASSEMBLY

ITEM	DESCRIPTION	PRICE
CHART TO THE LEFT	Sprinkler Only - (Specify Nozzle)	\$7.95
14291	1/4" x 36" Riser Assembly Only	\$3.95
14266	1/4" x 48" Riser Assembly Only	\$3.95
14267	36" Steel Stake	\$3.50
12166	48" Steel Stake	\$3.75

## MEGANET RISER ASSEMBLY PARTS

ITEM	DESCRIPTION	PRICE
16053	Top Quick Connect 1/2" FPT	\$1.20
15997	Bottom or Top Comp. Connection	\$0.60
15998	.40" Barb to Comp. Connection	\$0.60
15999	Comp. Plug (Plug for 15998)	\$0.60



# IRRIGATION

## NAANDAN JAIN® MODULAR GROUP

Performance Micro-Sprinklers and Sprayers

Sprinkler Selection Chart - All sprinklers calculated at 3' spacing.

# NAANDANJAIN

A JAIN IRRIGATION COMPANY

SPREADER OR SPINNER	FLOW RATE	HEIGHT	BENCH OR BED WIDTH															
			4'	5'	6'	7'	8'	10'	12'	14'	15'	16'	18'	20'	22'	24'		
Yellow Flat	Low	2'	G	O	O	O	-	-	-	-	-	-	-	-	-	-		
		4'	-	-	O	O	O	-	-	-	-	-	-	-	-	-		
	High	2'	Y	Y	Y	B	-	-	-	-	-	-	-	-	-	-		
		4'	-	-	B	B	-	-	-	-	-	-	-	-	-	-		
Green Kiwi	Low	4'	-	-	-	-	-	-	-	O	O	O	O	G	-	-		
		6'	-	-	-	-	-	-	-	O	O	O	O	O	O	-		
	High	4'	-	-	-	-	-	-	-	B	B	B	B	-	-	-		
		6'	-	-	-	-	-	-	-	-	B	B	B	B	-	-		
Black Round	Low	4'	-	-	-	-	-	O	O	-	-	-	-	-	-	-		
		6'	-	-	-	-	G	O	O	-	-	-	-	-	-	-		
	High	4'	-	-	-	-	Y	Y	Y	-	-	-	-	-	-	-		
		6'	-	-	-	-	Y	Y	Y	Y	-	-	-	-	-	-		
Black Single Wing	High	10"	-	-	-	-	-	-	O	O	O	O	-	-	-	-		
	Low	10"	-	-	-	-	-	-	-	B	B	B	B	-	-	-		
Orange Oblong	High	10"	-	-	-	-	-	-	-	-	-	-	Gy	Gy	Gy	G		
	Low	10"	-	-	-	-	-	-	-	-	-	-	-	O	O	O		

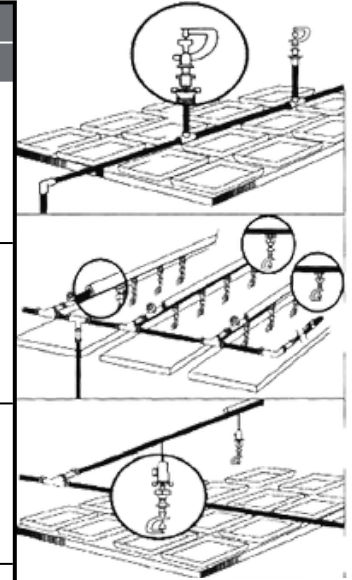

**Notes:**

- 10" Height is based on upright sprinkler setup.
- 24", 48", & 72" are based on inverted (hanging) setups.
- **Nozzle Color Codes: G=Green O=Orange Y=Yellow B=Blue Gy=Gray**

### SPREADER / SPINNER

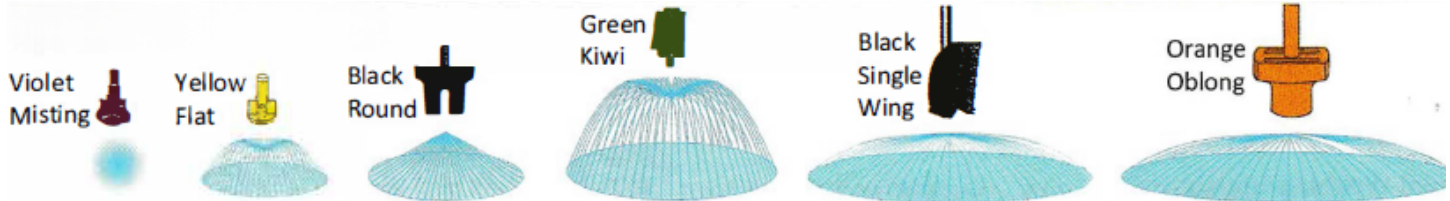

### NOZZLE & ANTI-MIST



ITEM	DESCRIPTION	PRICE
15110	Orange Anti-Mist	\$0.39
13200	Green Nozzle	\$0.32
13703	Orange Nozzle	\$0.32
15283	Yellow Nozzle	\$0.32
14087	Blue Nozzle	\$0.32
13614	Grey Nozzle	\$0.32
12047	Lavender Nozzle	\$0.32

Specify nozzle and spinner when placing your order.  
Thank You

### SPINNERS & SPREADERS

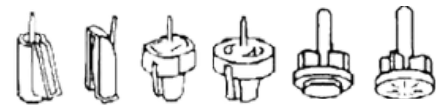

ITEM	DESCRIPTION	PRICE
13201	Black Round	\$0.39
13702	Green Kiwi	\$0.39
15049	Black Single Wing	\$0.39
13736	Orange Oblong	\$0.37
SPREADER		
12050	Yellow Flat	\$0.39
15215	Red Flat	\$0.39



# IRRIGATION

## UPRIGHT ASSEMBLY

Includes:

- Nozzle
- Spinner
- Bridge
- Stabilizing hanging tube
- 12" Stake

ITEM	LENGTH	PRICE
16138	24"	\$4.50
16139	36"	\$4.66
12292	48"	\$4.95



## STABILIZED HANGING TUBES (tubes, stabilizer, & butterfly mount)

ITEM	SIZE	PRICE
13186	24" Tube	\$2.25
15304	36" Tube	\$2.40
12697	48" Tube	\$2.95
13188	12" Stake	\$0.95



## GREENHOUSE HANGING ASSEMBLY INCLUDES

- Nozzle
- Spinner
- Bridge
- LPD
- Stabilized Hanging Tube

ITEM	LENGTH	PRICE
10400	24"	\$5.96
10774	36"	\$6.12
10399	48"	\$6.27



PLEASE SPECIFY NOZZLE AND SPREADERS FOR ASSEMBLIES WHEN ORDERING

## BRIDGE ASSEMBLY (BUTTERFLY)

Includes:

- Nozzle
- Spinner
- Bridge
- Butterfly



ITEM	PRICE
12046	\$1.64

## BRIDGE ASSEMBLY

Includes:

- Nozzle
- Spinner
- Bridge

ITEM	PRICE
12049	\$0.99

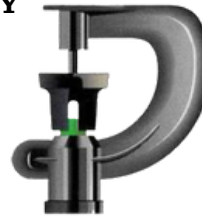

## LPD (ANTI-DRIP)

Use for stabilized hanging tubes only

Opens at 20 PSI  
Closes at 9PSI



ITEM	PRICE
12048	\$2.75



ITEM	DESCRIPTION	PRICE
15961	Male Threaded Base	\$0.95

## 1/2" MALE THREADED BASE

## AGRI-CONNECTOR

1/1" FPT x 3/16" Barb



ITEM	PRICE
15307	\$0.95

## NAANDAN JAIN® FOGGERS/MISTERS

Performance Micro-Sprinklers and Sprayers are commonly used for propagation, cooling, and humidification in greenhouses. Contact us for design information.

Recommended Pressure: 35-45 PSI.



14727



12921



12922



14725



14726



13057

ITEM	SIZE	PRICE
13057	Blue Fogger, 1.8 GPH	\$1.80
13058	Orange Fogger, 3.6 GPH	\$1.80
13059	Red Fogger, 5.4 GPH	\$1.80
13060	Black Foggers, 7.2 GPH	\$1.80
12921	LPD (Anti-Drip), Opens at 55 PSI, Closes 35 PSI	\$2.39
12922	4 Way Cross	\$2.20
14725	2 Way Tee	\$1.98
14726	45° Angle Adapter	\$0.75
14727	Plug	\$0.55



One fogger should be used for every 2.5 square feet. The cross with four foggers will cover up to 10 square feet (3 – 4 feet wide).

Foggers should be installed at a height of 3 – 5 feet above the propagation material. The spacing between the fogger assemblies should be 3 feet. Multiple flow rates available for different precipitation rates.

**3'-4' Bench:** One line above the center.  
**6'-7' Bench:** Two lines with crosses are required.

To prevent dry edges on a single bench (no other benches within 2') the cross should not be further than 1' from the edge. In some instances two lines may be required on a 4' bench.

## Installation Recommendations:

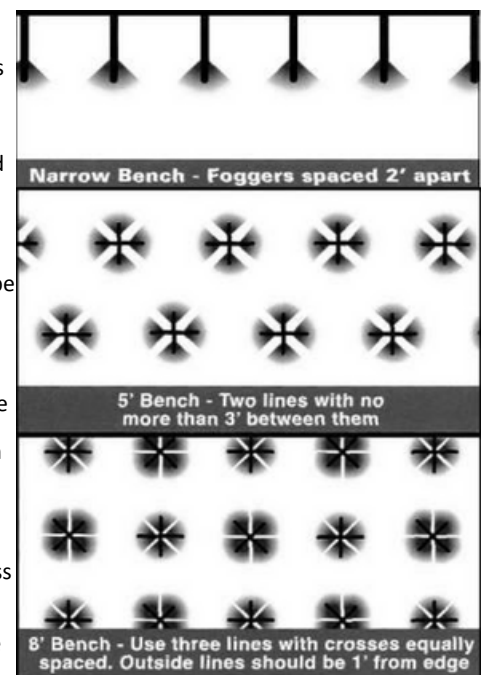

# IRRIGATION

## SENNINGER® MINI-WOBBLERS

Low-angle trajectory & good droplet size reduce wind drift and distortion of the spray pattern. Space & stagger these sprinklers at 30% less than listed diameter for uniform coverage.



Diameter Calculated 1.5' height

### MINI-WOBBLER, UPRIGHT

NOZZLE COLOR	LIGHT BLUE		BEIGE		GOLD		LIME		LAVENDER	
NOZZLE SIZE	#4	1/16"	#5	5/64"	#6	3/32"	#7	7/64"	#8	1/8"
Nozzle PSI	GPM	Dia.	GPM	Dia.	GPM	Dia.	GPM	Dia.	GPM	Dia.
15	0.42	26.5	0.64	31.0	0.95	33.0	1.30	25.0	1.67	35.5
20	50	28.0	0.75	33.5	1.10	36.0	1.53	37.5	1.95	38.5
25	0.56	28.0	0.84	35.0	1.25	37.0	1.96	38.5	2.18	43.0

### I-MINI-WOBBLER, INVERTED

Diameter calculated at 6' height.

Riser Assembly 1/2" FPT x barb. Use 4961 punch. Use 1/2" or 3/4" pipe or 5/16" rod for stake.

NOZZLE COLOR	BEIGE		GOLD		ITEM	DESCRIPTION	PRICE
NOZZLE SIZE	#5	5/64"	#6	3/32"			
Nozzle PSI	GPM	Dia.	GPM	Dia.			
20	0.75	32.0	1.10	34.0	13173	W/36" tube	\$3.95
25	0.84	32.5	1.25	34.5	14202	w/48" tube	\$3.95

ITEM	DESCRIPTION	PRICE
<b>UPRIGHT MINI-WOBBLER®</b>		
13127	Upright mini-Wobbler, #4 Blue Nozzle	\$4.10
13128	Upright mini-Wobbler, #5 Beige Nozzle	\$4.10
13129	Upright mini-Wobbler, #6 Gold Nozzle	\$4.10
13130	Upright mini-Wobbler, #7 Lime Nozzle	\$4.10
13132	Upright mini-Wobbler, #8 Lavender Nozzle	\$4.10

<b>INVERTED MINI-WOBBLER®:</b>		
14728	Inverted mini-Wobbler, #5 Beige Nozzle	\$4.10
13465	Inverted mini-Wobbler, #6 Gold Nozzle	\$4.10

<b>REPLACEMENT NOZZLES:</b>		
14729	#4 Blue Nozzle for mini-Wobbler	\$0.75
14730	#5 Beige Nozzle for mini-Wobbler	\$0.75
14731	#6 Gold Nozzle for mini-Wobbler	\$0.75
14732	#7 Lime Nozzle for mini-Wobbler	\$0.75
14044	#8 Lavender Nozzle for mini-Wobbler	\$0.75

## SENNINGER® XCEL-WOBBLERS

The Xcel-Wobbler uses Senninger's offcenter rotary-action technology. It provides an extremely uniform and instantaneous application pattern over a large area at lower pressures, and with very low evaporative loss and wind drift. Wobblers are designed for nursery irrigation and frost protection. Wobblers installed in test bed withstood winds up to 25 MPH and temperatures as low as 18°. They are an excellent sprinkler for small diameters from 35 to 56 feet. The Xcel has less vibration than earlier models.

Connection: 1/1" MPT. Operating Pressures: 10 - 25 PSI. Space and stagger these sprinklers at 30% less than listed dia. for uniform coverage.

NOZZLE COLOR	GOLD		LAVENDER		TURQUOISE		RED		BLUE		ORANGE	
NOZZLE SIZE	#6	3/32"	#8	1/8"	#10	5/32"	#12	3/16"	#14	7/32"	#16	1/4"
Nozzle PSI	GPM	Dia.	GPM	Dia.	GPM	Dia.	GPM	Dia.	GPM	Dia.	GPM	Dia.
10	0.78	36.5	1.4	42.0	2.22	44.5	3.23	46.0	4.40	47.0	5.61	48.0
15	0.95	41.0	1.71	46.5	2.72	49.0	3.96	50.5	5.39	51.0	7.88	52.5
20	1.10	45.0	1.98	47.0	3.14	50.5	4.57	52.0	6.23	53.0	9.63	55.0
25	1.23	46.0	2.21	51.5	3.51	53.5	5.11	54.5	6.97	55.5	11.01	56.5

Diameter at 1.5' height.



ITEM	DESCRIPTION	PRICE
4850	Xcel-Wobbler, #6 Gold Nozzle	\$7.95
4962	Xcel-Wobbler, #8 Lavender Nozzle	\$7.95
13170	Xcel-Wobbler, #10 Turquoise Nozzle	\$7.95
14012	Xcel-Wobbler, #12 Red Nozzle	\$7.95

<b>REPLACEMENT NOZZLE:</b>		
14733	#6 Gold Nozzle for Xcel-Wobbler	\$0.85
15308	#7 Lime Replacement Nozzle for Xcel-Wobbler	\$0.85
14734	#8 Lavender Nozzle for Xcel-Wobbler	\$0.85
4963	#10 Turquoise Nozzle for Xcel-Wobbler	\$0.85
4964	#12 Red Nozzle for Xcel-Wobbler	\$0.85
14735	#14 Blue Nozzle for Xcel-Wobbler	\$0.85
12024	#16 Orange Nozzle for Xcel-Wobbler	\$0.85



# IRRIGATION



## GARDEN HOSE SHUT-OFF

All standard garden hose connections, FHT X MHT

ITEM	DESCRIPTION	PRICE
10444	Long Handle Plastic	\$2.00
13718	Short Handle Plastic	\$2.95
15777	Dramm QAV Plastic Shutoff, High Flow	\$4.95
15778	Dramm Hi Flow Shutoff Valve BLUE	\$15.75
10189	Dramm Brass Shutoff	\$19.95
14009	Dramm Aluminum Shutoff	\$18.59

## GARDEN HOSE WYE

Standard, FHT x MHT, with shut-offs on both outlets.

ITEM	DESCRIPTION	PRICE
3725	Two-way - brass	\$7.95
10441	Two-way - plastic	\$2.85
3727	Four-way - zinc	

## GARDEN HOSE ENDS & COUPLERS

Brass fittings include zinc clamp except on hose ends  
\*clamps not included.

Plastic fittings include plastic clamp.

ITEM	DESCRIPTION	PRICE
3722	HD Brass, 5/8" - 3/4" Male	\$5.25
3723	HD Brass, 5/8" - 3/4" Female	\$5.39
3724	HD Brass, 5/8" - 3/4" Inline Mender	\$7.35

ITEM	DESCRIPTION	PRICE
11178	Plastic, 1/2" - 5/8" Female Hose End	\$1.25
15776	Plastic, 5/8" - 3/4" Female Hose End	\$1.39
11179	Plastic, 1/2" - 5/8" Male Hose End	\$1.29
11176	Plastic, 5/8" - 3/4" Male Hose End	\$1.29
11180	Plastic, 1/2" - 5/8" Mender	\$1.25
11177	Plastic, 5/8" - 3/4" Mender	\$1.39
11181	Brass, 1/2" Insert, Set = both FHT & MHT*	\$7.95
11182	Brass, 5/8" Insert, Set = both FHT & MHT*	\$7.95
10205	Brass, 3/4" Insert, Set = both FHT & MHT*	\$7.95
10854	1" Insert x Female Hose End*	\$6.95
15794	1" Insert x Male Hose End*	\$7.85



Plastic Shutoff



Metal Shutoff



Garden Hose Wye - 2 way



Female Hose End



Male Hose End



Hose Coupler

## GARDEN HOSE WASHERS & END CAP

ITEM	DESCRIPTION	PRICE
11184	Black Hose Washers (Pack of 12)	\$1.19
10269	HD Red Hose Washers (Bag of 10)	\$1.29
3728	Garden Hose End Cap, FHT	\$0.42

## DRAMM BRASS HOSE SWIVEL

Live swivel, works under pressure. Reduces kinks & twists in hose.

ITEM	DESCRIPTION	PRICE
11172	Dramm Live Hose Swivel	\$14.25

## GARDEN HOSE ADAPTERS

ITEM	DESCRIPTION	PRICE
11186	PVC, MHT x 3/4" Soc (1" Spig)	\$1.39
11187	PVC, FHT x 3/4" Soc (1" Spig)	\$3.59
11188	PVC, MHT x 1/2" Soc (3/4" Spig)	\$1.39
11189	PVC, FHT x 1/2" Soc (3/4" Spig)	\$3.49
11190	Brass, MHT x 3/4" MPT (1/2" FPT)	\$3.35
11191	Brass, MHT x MHT (1/2" FPT)	\$3.35
11192	Brass, FHT swivel x 1/2" MPT	\$5.70
4848	Brass, FHT swivel x 3/4" FPT	\$4.55
11193	Brass, FHT x FHT swivel	\$3.95
10836	Plastic, FHT swivel x 3/4" MPT	\$3.49

## GARDEN HOSE QUICK COUPLER

These handy quick couplers are designed without a valve for maximum flow and allow water flow when disconnected.

ITEM	DESCRIPTION	PRICE
10186	Brass Female Quick Coupler	\$5.09
10185	Brass Male Quick Coupler	\$2.85



10186 & 10185



11190



11191



11192



4848



11193



Brass Hose End Set

10836



11188

# IRRIGATION



## WONDER WATERER



ITEM	DESCRIPTION	PRICE
4577	Wonder Waterer	\$32.50
10235	Replacement Face Plate	\$6.95
10270	Replacement Filter Screen	\$3.80
11159	Filter Case only	\$5.95
15500	Replacement Face Plate Retaining Ring	\$8.00

## INSULATED PISTOL GRIP NOZZLE

This Gilmour® nozzle has an insulated molded grip. Heavy-duty zinc body, male hose threaded front.



ITEM	DESCRIPTION	PRICE
10290	Gilmour® Pistol Grip Nozzle	\$6.95

## FOGG-IT NOZZLE

These fine volume misting nozzle are a great aid in watering cuttings, delicate stock and hand misting. All bronze.



ITEM	DESCRIPTION	PRICE
11160	FOGG-IT nozzle, 1 gpm	\$9.95
11161	FOGG-IT nozzle, 2 gpm	\$9.95
15484	FOGG-IT nozzle, 4 gpm	\$10.95

## DRAMM® REVOLVER SPRAY GUN

This heavy-duty spray nozzle has nine spray patterns which can easily be changed with the quick-click pattern changing. Ergonomic insulated grip.



ITEM	DESCRIPTION	PRICE
11162	Dramm® Revolver	\$11.00

## DRAMM® SYPHONJECT

Fertilize while you water. Garden hose connection. The average rate is 20:1. Requires 35 psi at faucet and 3-5 GPM flow.



ITEM	DESCRIPTION	PRICE
11173	Dramm® Syphonject™ Siphon Mixer	\$17.00

## DRAMM® LEVER ACTIVATED VALVE

Full flow (up to 11 gpm) squeeze valve with garden hose connections



ITEM	DESCRIPTION	PRICE
10188	Dramm® Lever Activated Valve	\$13.95

## DRAMM® COLORSTORM™ HOSE

Dramm ColorStorm-Professional Rubber Hose is made from EPDM rubber for a "crackless" hose cover that is resistant to abrasion and weathering. Heavy, hex shape that resists kinking.



PRE-ASSEMBLED, WITH CRIMPED NICKEL-PLATED ENDS:

ITEM	DESCRIPTION	PRICE
11163	ColorStorm Hose 3/4" x 50'	\$116.00
11164	ColorStorm Hose 3/4" x 75'	\$156.75
10440	ColorStorm Hose 3/4" x 100'	\$176.95
11165	ColorStorm Hose 5/8" x 50'	\$72.95
11166	ColorStorm Hose 5/8" x 75'	\$119.85
11167	ColorStorm Hose 5/8" x 100'	\$126.95

## CONTRACTOR FARM 3/4" KINK FREE HOSE

High performance lead-free brass couplings, drinking water safe, phthalate Safe. Kink free Duraflow technology. High performance burst - 600 psi.



ITEM	DESCRIPTION	PRICE
3510	3/4" x 50'	\$85.39
3511	5/8" X 50'	\$65.95

## WATER BREAKERS

High-quality Dramm® water breakers are made from impact-resistant ABS plastic with a stainless steel face plate.



ITEM	DESCRIPTION	SPRAY PATTERN	PRICE
4664	RedHead	Soft, High Flow, Medium Pattern	\$12.00
10257	OrangeHead	Soft, High Flow, Wide Pattern	\$12.00
4901	LemonHead	Soft, Medium Flow	\$12.00
10258	BlueHead	Full Flow for drenching	\$8.00

## DRAMM® HANDI-REACH HANDLES

Standard garden hose connections.

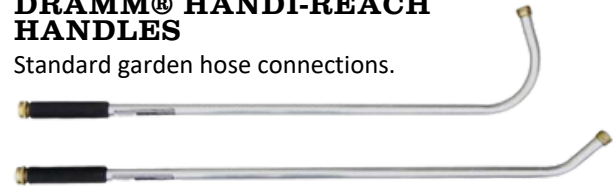

ITEM	DESCRIPTION	PRICE
12502	16" Handi-Reach Handle, 45° and 90° angel	\$9.00
4671	24" Handi-Reach Handle, 45° angle	\$10.00
4665	36" Handi-Reach Handle, 45° angle	\$11.50
10259	48" Handi-Reach Handle, 45° angle	\$12.95
10260	36" w/90° angle for hanging baskets	\$11.80

## Other Nozzles Available



# FARM SUPPLIES

## PICKING BASKETS

The original picking basket. Long-term durability. Smooth rounded edges to prevent fruit and vegetable bruising.



	5041	13012
<b>CAPACITY:</b>	5/8 Bushel	1/2 Bushel
<b>DIAMETER (OD):</b>	15.5"	14.5"
<b>HEIGHT:</b>	13.25"	12.25"
<b>MATERIAL:</b>	Polyethylene, UV Stabilized, FDA approved	
<b>DRAINAGE:</b>	Ventilated bottom and sides	
<b>STORAGE:</b>	Nests for storage	
<b>WEIGHT:</b>	1.76 Lb.	1.16 Lb.

ITEM	DESCRIPTION	PRICE
5041	5/8 Bushel Green Basket	\$9.95
13012	1/2 Bushel Red Basket	\$8.75
15844	5/8 Bu solid, No side vents	\$11.45

## METAL BASKET HANDLE

(Pictured below)

This metal basket handle is designed for both 5/8 or 1/2 bushel baskets. Unique design grabs and releases baskets quickly and effortlessly. It is ideal to comfortably carry baskets out of high tunnels.

ITEM	DESCRIPTION	PRICE
10688	Metal Basket Handle	\$35.39

## HD PICKING BASKET

Same size as the 5/8 bu. above, but it is heavier duty and has no vents or drain holes. Reduces bruising.

<b>CAPACITY:</b>	5/8 Bushel
<b>DIAMETER (ID):</b>	13.75"
<b>HEIGHT:</b>	13"
<b>WEIGHT:</b>	2.2 Lb.
<b>DRAINAGE:</b>	Solid sides & bottom
<b>STORAGE:</b>	Nests for storage



ITEM	DESCRIPTION	PRICE
5021	5/8 Bushel Red Basket	\$11.50

## PIK-AID CART

A great back saver. No more dragging along heavy baskets with tomatoes, etc., or having mud collect on the bottom of baskets. Carries up to 30 empty 5/8 bu. Baskets or 5-gallon buckets. 10" flat-free foam-filled tires. Wheel base: 20" width. Expanded metal floor.



ITEM	DESCRIPTION	1-2
13633	Pik-Aid Cart w/ 10" Tires	\$129.95

## ALL PURPOSE BASKET 1.25

This all-purpose basket is the original design durable and dependable. Strong flexible UV Stabilized polyethylene. Also know as fish Basket.



<b>CAPACITY:</b>	1.25 Bushel
<b>WEIGHT:</b>	3.5 Lb.
<b>DIMENSIONS:</b>	D 19.1" x H 17"
<b>DRAINAGE:</b>	Ventilated sides & bottom
<b>STORAGE:</b>	Nests for storage

ITEM	DESCRIPTION	PRICE
3803	All Purpose, 1.25 Bushel	\$15.50
11815	Replacement Handle	\$2.50

## ALL PURPOSE BASKET 1 BUSHEL

- Four handles for easy transfers from one person to the next.
- Handles integrated into the basket allow for tight stacking —(1" stacking height).
- Concave sides for comfortable carrying even when heavily loaded.
- The design allows for tight nesting, reducing unused space.
- Flexible polyethylene with UV stability.
- One bushel fill line molded in the basket.
- Six baskets interlock to form a single layer on a standard 42" x 48" pallet.



<b>CAPACITY:</b>	1 Bushel
<b>WEIGHT:</b>	4 Lb.
<b>DIMENSIONS:</b>	L 19.5" x W 16.5" x H 15.5"
<b>DRAINAGE:</b>	Ventilated sides & bottom
<b>STORAGE:</b>	Nests for storage

ITEM	DESCRIPTION	PRICE
10414	All Purpose, 1 Bushel	\$12.95

**QUANTITY DISCOUNTS AVAILABLE**

# FARM SUPPLIES

## GENERAL PURPOSE CONTAINER 1.75 BU.

Ideal for harvesting, storing and transporting sweet corn, melons, lettuce and many other fruits and vegetables.



<b>CAPACITY:</b>	1.75 Bushel (75 to 80 Lb.)
<b>DIMENSIONS (OD) :</b>	L 23.5" x W 18.5" x H 12.25"
<b>MATERIAL:</b>	Polyethylene, UV Stabilized, FDA approved
<b>DRAINAGE:</b>	Ventilated bottom and sides
<b>STORAGE:</b>	(Half turn) Stack to Nest
<b>WEIGHT:</b>	5.6 Lb.

ITEM	DESCRIPTION	1-24	25+
4145	Green 1.75 Bu. Container	\$21.85	\$21.50
12263	Red 1.75 Bu. Container	\$21.85	\$21.50

## UTILITY BOX, 1.22 BUSHEL

Ideal for harvesting, transporting and storing small fruits & vegetables.

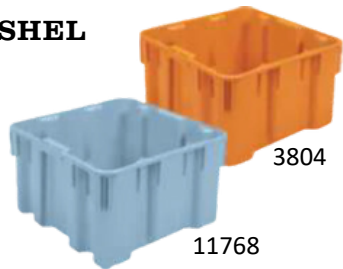

<b>CAPACITY:</b>	Capacity: 1.22 Bushel (40 to 45 Lb.)
<b>DIMENSIONS (OD) :</b>	L 19" x W 19" x H 10.5"
<b>MATERIAL:</b>	Polyethylene, UV Stabilized, FDA approved

ITEM	DESCRIPTION	PRICE
11768	Blue Box, No Drain Holes	\$18.50
3804	Orange Box, W/Drain Holes	\$18.25

## SMALL PLASTIC BASKETS

Tired of staples in wooden baskets? These baskets are made from UV-treated polyethylene and stack and unstack with ease.



ITEM	DESCRIPTION	COLOR	DIA.	HEIGHT	1-49	50+
14833	1/4 Peck (2 Quarts)	Red	6.75"	5.00"	\$2.95	\$2.85
14834	1/2 Peck (4 Quarts)	Beige	8.75"	5.75"	\$4.20	\$3.95
10413	1 Peck (8 Quarts)	Green	11.5"	6.50"	\$6.95	\$6.80

## HARVEST CONTAINERS



	10632	4667	10411
<b>COLOR:</b>	Gray	Yellow	Yellow
<b>CAPACITY:</b>	7/8 Bu.	7/8 BU.	1-1/8 BU.
<b>LENGTH:</b>	24"	23.6"	23.8"
<b>WIDTH:</b>	16.13"	15.7"	17.8"
<b>HEIGHT:</b>	7.25"	7"	7.6"
<b>MATERIAL:</b>	Polyethylene	High-Density Polyethylene	
<b>DRAINAGE:</b>	Ventilated bottom and 2 sides		
<b>STORAGE:</b>	(Half turn) Stack to Nest		
<b>WEIGHT:</b>	3.1 Lb.	3.25 LB.	4 LB.

ITEM	DESCRIPTION	PRICE
10632	7/8 Bu. Gray Container	\$14.85
4667	7/8 Bu. Yellow Container	\$18.55
10411	1-1/8 Bu. Yellow Container	\$19.50

## SOFT BOTTOM WOODEN BASKETS

Ideal for harvesting, storing and transporting sweet corn, melons, lettuce and many other fruits and vegetables.



ITEM	DESCRIPTION	1-49	50+
10268	1 Peck, 11" Diameter x 7" Tall	\$4.85	\$4.55
2815	1/2 Bushel, 14" Diameter x 9" Tall	\$5.65	\$5.25
2814	Bushel, 17" Diameter x 12 1/4" Tall	\$6.95	\$5.95

## 4-QUART BASKET

Combine a bucket and basket?  
Answer.. The basket!

The vented base allows air flow and drainage to keep your produce fresh and the convenient handle is your solution to carrying fruits and vegetables from the farm to the market, produce stand and beyond.



ITEM	DESCRIPTION	PRICE	150 +
16120	4-Quart basket with wire handle	\$1.95	\$1.80

## WOODEN BERRY BOXES

Quart size. A full case contains 500 pieces.



ITEM	DESCRIPTION	EA	PRICE
4362	Wooden Berry Boxes	\$.039	\$165.00



# FARM SUPPLIES

## RUBBER BANDS, ADVANTAGE

Premium quality.



ITEM	SIZE	COLOR	PCS/LB	TYPICAL USE	
13199	4 1/2" x 3/16"	1R	Red	200	Cauliflower
4448	4 1/2" x 3/16"	1G	Green	200	Cauliflower
14835	4 1/2" x 3/16"	1Y	Yellow	200	Cauliflower
14836	4 1/2" x 3/16"	1B	Blue	200	Cauliflower
10637	3" x 4"	63	Red	380	Beets, etc.
4449	2 1/2" x 4"	62	Red	450	Asparagus, Broccoli, etc.
4450	3 1/2" x 1/8"	33	Red	475	All purpose
12545	3" x 1/8"	32	Red	700	Indian Corn, etc.
10449	2" x 1/8"	30	Red	1,150	Indian Fingers, etc.
12638	2 1/2" x 1/16"	16	Red	1,800	Radish, Onions
10634	2" x 1/16"	14	Red	2,250	Radish, etc.
ALL BANDS ARE SOLD IN 1 LB. BAGS			1-24	25+	
See above for item # and size.			\$5.50	\$4.95	

## WINMORE PACKING TAPE

Good adhesive, even in coolers.

ITEM	DESCRIPTION	1-24	25+
11911	Clear 2" x 330'	\$3.25	\$2.95
14837	Tan 2" x 330'	\$3.25	\$2.95

## CARTON CLOSING STAPLER AND STAPLES

ITEM	DESCRIPTION	PRICE
15857	1-1/4" Hand Stapler	\$219.95
15859	1-1/4" Staples Box 2,500/CS	\$11.95



## WAXED VEGETABLE BOXES 15/BDL



ITEM	SIZE	PRICE
13788	1/2 bushel	\$28.95
15339	3/4 bushel	\$49.50
13751	1-1/9 bushel	\$56.20
4353	1 bushel	\$49.95

## 50LB WAXED CABBAGE BOX



Waxed cardboard cabbage box, holds 50lb of cabbage.

ITEM	PRICE
12316	\$4.90 ea

## 25 LB TOMATO BOX W/O LID



Cardboard Box. Lid sold separately.

ITEM	PRICE
15046	\$2.35 ea

## 25 LB TOMATO BOX LID



ITEM	PRICE
15044	\$0.88 ea

## 10 LB, 1 LAYER CARTON



ITEM	PRICE
15045	\$1.75 ea

## PUMPKIN BIN, PLAIN



Plain No Flap - 46 X 37 X 36.

Seasonal items, please order early!

ITEM	PRICE
4166	\$29.00 ea

# DISCOUNTS AVAILABLE FOR FULL PALLETS ON BOXES.



# FARM SUPPLIES

## BERIGARD® MOLDED FIBER BERRY BOXES



ITEM	SIZE	PCS/CS	WT.	1-29	30+
2525	1/2 Pint	600	21 lb.	\$72.95	\$69.50
11887	Pint	420	18 lb.	\$55.50	\$51.30
13525	Quart	297	18 lb.	\$58.95	\$54.95

## SHIPPERS/HI-STACKERS FOR BERRY BOXES

White cardboard with red print: "Quality Berries" on the quart size and "Farm Fresh Produce" on the pint and 1/2 pint sizes.

ITEM	DESCRIPTION	BUNDLE	PALLET
13772	8 Count Quart Hi-stacker	\$122.50/50bdl	CALL
10416	12 Count 1 Pint shipper	\$101.25/50bdl	CALL
12283	12 Count 1/2 Pint shipper	\$85.00/50bdl	CALL

## PT/QT VEX CAPS

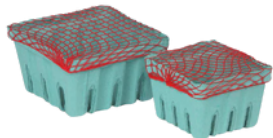

Fits 1 pint/quart pulp or wooden baskets. Call for availability.

ITEM	DESCRIPTION	PRICE
4441	100/BAG	\$14.95
4095	1000/CASE	\$118.50

## APPLE BAGS



ITEM	DESCRIPTION	PRICE
4184	1/2 Peck (500/Cs) Plastic	CALL
4184-50PK	1/2 Peck (50/Cs) Plastic	CALL
4185	1 Peck (500/Cs) Plastic	CALL
13871	1/2 Bushel (250/Cs) Plastic	CALL
5102	1/2 Peck (500/Cs) Paper	CALL
13870	1 Peck (500/Cs) Paper	CALL
4186	1/2 Bushel (250/Cs) Paper	CALL

## CORN BAGS



ITEM	DESCRIPTION	PRICE
3118A	Green Mesh 5 dz	\$0.58
13846	Clear Plastic 1 dz 1,000/CASE	\$99.00

## ALUMINUM BERRY CARRIER



Holds 8 - 1 Quart Boxes. It features twin carrying handles that fold to the side of the tray for easy storage.

ITEM	DESCRIPTION	PRICE
10415	Aluminum Berry Carrier	\$37.95





# FARM SUPPLIES

## HAND TOOLS



14895



14896



14901



14902



14897



14898



746



10739



13520



12889



14839



14905



14839



13766



14904



10438



13628



15354

ITEM	DESCRIPTION	PRICE
14895	Euro-Pro Bypass Pruner 7-3/4", small horticulture pruner with a one-hand locking mechanism	\$21.95
14896	Euro-Pro Bypass Pruner 9", large horticulture pruner with a one-hand locking mechanism	\$21.95
14901	Classic Professional Pruner, 1" cut, 8.5" long. Classic manual pruning shears that is easy to adjust	\$33.95
14902	Bypass Pruner Angled Head Forged 8-1/2". Ergonomical professional pruner. 1" cut	\$33.95
14897	Bypass Pruning Shear Ergo Swiss Style 7". Lightweight and built for smaller hands.	\$12.95
14898	Pruner HD Cut-n-Hold. Perfect for cutting roses and other thorny plants.	\$ 16.95
746	HD Hand Pruner, Classic Cut Bypass Pruner, resharpenable forged steel blade, cuts up to 3/4"	\$21.95
10739	Snip, Stainless Steel Long Straight Snip, unobtrusive leather strap lock, 1-3/4" pointed blade	\$10.00
13520	Universal Tool Scabbard, nylon construction, 5" deep pouch fits hand pruners, snips etc.	\$10.00
12889	HD Lopper, Dual Cut Bypass Lopper, fully forged steel construction, 31" handle, cuts up to 2"	\$42.35
14839	Economy Lopper, ComfortGEL Bypass Lopper, non-stick blade, 30" handle, cuts up to 1-1/2"	\$25.00
14905	Sod/Harvest Knife Straight/serrated 3". Great all purpose utility knife.	\$3.95
13766	Small harvesting knife with 7" HD stainless steel blade and textured non-slip handle	\$8.95
14904	Harvest Knife Sheath w/ SS rivets and belt clip; easily fits a 7-3/4" long x 2-1/8" wide knife blade	\$10.95
10438	Large harvesting knife with 12" HD stainless steel blade and textured non-slip handle	\$10.75
13628	Machete, 18" resharpenable tempered steel blade, riveted non-slip handle	\$10.95
15354	Fruit Harvest Bag, steel rimmed. 44lbs picking apron with padded back.	\$55.50

# FARM SUPPLIES

## ROUND TOMATO CAGE

Heavy duty round tomato cage with 4 legs and 3 rings, 36" high. Top ring diameter: 16" Bottom ring diameter: 13"

ITEM	1-99	100-499	500+
11792	\$6.95	\$6.65	\$6.30

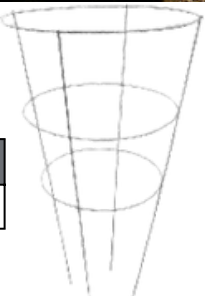

## HEAVY DUTY SQUARE TOMATO CAGE

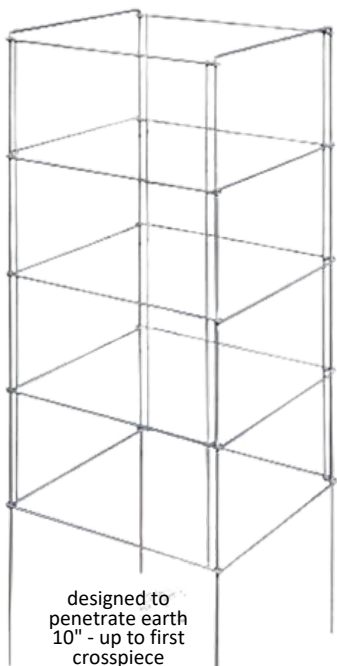

designed to penetrate earth 10" - up to first crosspiece

row cover friendly - no rips



folds easy for hanging and storage

13½" square, all galvanized steel, spot welded. Top corners are rounded, excellent for use with row cover. Folds for ease of handling and storage. Double corner posts for greater strength and stability.

ITEM	1-99	1-99	100-149	150+
11800	Standard 40" high	\$14.95	\$14.50	\$12.95
10633	Tall 56" high	\$15.89	\$14.99	\$14.55

## GRAFTING TUBE CLIPS

Tube-shaped grafting clips for use with tomatoes and cucurbits. Multiple color coded sizes available for various stem widths. Flexible food-grade silicone.



ITEM	DESCRIPTION (5000 CS)	1-3	4+
16140	1.7 mm Violet Clip	\$100.00	\$90.00
16141	2 mm Blue Clip	\$107.00	\$95.00
16143	2.2 mm Red Clip	\$121.00	\$110.00
16144	2.5 mm Clear Clip	\$150.00	\$130.00
16145	11cm Support Straw	\$85.00	\$80.00

## GREENHOUSE TOMATO TRELLIS

Galvanized steel

Are you tired of extending tomato stakes when your plants outgrow them? This is a labor-saving device for trellis greenhouse tomatoes. Designed with determinate tomato plants in mind, especially grafted plants or varieties that grow too tall for tomato stakes. It will only work with greenhouses that have crossties on each arch. To install: Run a purlin pipe the length of the row (over top of the crossties), then hang these trellises between every other plant. Brace first and last trellis (see picture for brace idea). Then, install tomato twine as needed to support the growing plants. Installing twine is easy, even once the plants are 5-plus feet tall. Cut as needed to fit structure heights. For taller structures, you may need to use short stakes for the first row or two of twine.



ITEM	DESCRIPTION	PRICE
13742	98" Long, 12 hooks	\$10.45
14208	108" Long, 12 hooks	\$10.55

## GREENHOUSE TOMATO TRELLISING HOOKS



For trellising greenhouse tomatoes and cucumbers, etc. Hang on a high wire. Or use S-hooks to hang from a pipe.

**Twine Hook:** Wire hook releases approximately 7" of twine each time they are turned over; the 11976 includes 30 ft. of UV-resistant white twine prewrapped on the hook and 10 ft. loose, so it can free-fall out of the case to speed installation.

**Roller Hook:** A labor-saving device to lower/lean crops smoothly controlled. Heavy-gauge wire frame supports a spool of twine with 100' of UV-resistant white twine. It easily clips over the wire. Concurrently releases twine while sliding down the wire to lower and lean trellised crops.

ITEM	DESCRIPTION	EACH	PCS/CASE
11976	Metal Hook With TWINE , 12 Meters	\$0.39	420/0.36 ea
4301	Bare Twine Hook, use HD twine	\$0.18	984/0.16 ea
11890	Roller Hook Frame (wire part)	\$0.27	550/0.24 ea
11891	Roller Hook Spool W/80' twine	\$0.47	550/0.41 ea
15067	Roller Hook AND Spool 105' twine	\$0.49	N/A



# FARM SUPPLIES

## TREATED TOMATO STAKES

Sharpened Honduras Pine Stakes. Pressure treated, rot-resistant wood. Sold in packs of 25 pieces.

ITEM	DESCRIPTION	25-SKID	SKID DISCOUNT
3483	1" x 1"x 48"	\$1.20	\$1.15 (1400/SKID)
3574	1" x 1"x 60"	\$1.45	\$1.35 (1400/SKID)
3575	1 1/4" x 1 1/4"x 72"	\$2.55	\$2.45 (1050/SKID)
14841	3/4" x 1"x 48"	\$0.95	\$0.92 (1575/SKID)

## HEAVY DUTY WINMORE TYING TWINE 6500'



Good for use in the greenhouse or the field.

ITEM	COLOR	SIZE	PRICE
4296	Blue/White	7.5 LBS	\$26.95

## BLACK VINE CLIPS

When growing tall plants or vine crops, these are used to clip the plant to a string or trellis support wire. They are primarily used by tomato, cucumber, and pepper growers. UV Stabilized. 23 mm



ITEM	WIDTH	DESCRIPTION	PRICE
4821	23 mm	Box/1,000	\$17.75
11892	23 mm	Case/10,000	115.00

## BATO VINE CLIPS - TERRA COTTA

ITEM	WIDTH	DESCRIPTION	PRICE
15875	25 mm	Case/9,000	\$125.50
7361	25mm	Case/9,000 Biodegradable	\$477.65

**NOT STOCKED - CALL TO ORDER**

## UNTREATED WHITE OAK TOMATO STAKES

Sold in packs of 25. For organic growing. Uniform 1"x 1 1/4" square, sharpened.

ITEM	HIEGHT	EACH	SKID OF 1050
4938	48"	\$0.89	\$0.85
4661	60"	\$1.15	\$1.05
4898	72"	\$1.29	\$1.22
15489	96"	\$1.75	

## TOMATO TWINE 6300'



Quality white twine, box has a belt loop.

ITEM	PRICE
4298	\$8.30

## MEASURING PITCHERS



Durable construction made from food grade Opolyptopylene with steep resistance to a variety of chemicals. Measurement in US fl. Oz and metric debossed in black to be easily read. Excellent pouring control and provide entire control from a fine trickle to a fast pour.

ITEM	DESCRIPTION	PRICE
381	128 oz.	\$13.59
382	64 oz.	\$9.99
1860	32 oz.	\$8.99
1859	16 oz.	\$8.09
383	8 oz.	\$7.69



# SOILS



## METRO-MIX® 830

Metro-Mix® 830 is a versatile middleweight bark-based mix suitable for various crop plants across multiple container sizes, from cell flats to larger pots.

ITEM	DESCRIPTION	SIZE	SKID QTY	PRICE
11646	Metro-Mix® 830	2.8 cfl	48	\$17.35
15351	Metro-Mix® 830	60 cfl	2	CALL

## METRO-MIX® 852

The heavyweight mix, formulated for outdoor containers and large interior pots, contains a high percentage of bark and is ideal for growing perennials, roses, and nursery containers.

ITEM	DESCRIPTION	SIZE	SKID QTY	PRICE
12816	Metro-Mix® 852	2.8 cfl	42	\$18.95
15353	Metro-Mix® 852	60 cfl	40	CALL

## METRO-MIX® 865

A heavyweight mix for perennial growers. Contains a high bark content for superior drainage and excellent container stability. Suitable for rooftop garden

ITEM	DESCRIPTION	SIZE	SKID QTY	PRICE
12971	Metro-Mix® 865	2.8 cfl	48	\$18.95

## SUNSHINE® MIX #1

The most versatile and popular professional mix, Sunshine® Mix #1, is recommended for producing a wide variety of container-grown crops, from vegetables to bedding plants and cuttings. It offers a mix of sphagnum peat moss, perlite, and nutrients that professional growers rely on year after year.

ITEM	DESCRIPTION	SIZE	SKID QTY	PRICE
12884	Sunshine® Mix #1-F1P Rsi	2.8 cfl	54	\$16.95
12839	Sunshine® Mix #1-F1P Rsi	3.8 cfc	30	\$29.95

## SUNSHINE® MIX #1 NATURAL & ORGANIC WITH EARTHWORM CASTINGS

The natural and organic professional mix that growers use to grow various crops. Sunshine® #1 Natural & Organic is an OMRI Listed® blend that offers a balance of peat moss and coarse perlite that professional growers rely on yearly.

ITEM	DESCRIPTION	SIZE	SKID QTY	PRICE
15347	Sunshine® Mix #1 N&O Rsi + EWC (OMRI)	2.8 cfl	51	\$17.95

## SUNSHINE® MIX #5

Sunshine® Mix #5 is designed to enhance root development in the propagation of ornamental and vegetable transplants.

ITEM	DESCRIPTION	SIZE	SKID QTY	PRICE
12886	Sunshine® Mix #5 RSi	2.8 cfl	54	\$18.95
12882	Sunshine® Mix #5 RSi	3.8 cfc	30	\$29.95

## SUNSHINE® MIX #15

This multi-purpose formulation is the mix that expert growers select for producing a wide variety of crops. Ready to Gro!

ITEM	DESCRIPTION	SIZE	SKID QTY	PRICE
12883	Sunshine® Mix #15-F15 Rsi	2.8 cfl	54	\$15.95
12881	Sunshine® Mix #15-F15 Rsi	3.8 cfc	30	\$28.95

## BLACK GOLD® RETAIL PRODUCTS

Premium Soilless Mixes, Amendments, and Fertilizers: Trusted Yearly by Home Growers, OMRI Listed.

ITEM	DESCRIPTION	SIZE	SKID QTY	PRICE
15350	Black Gold® All Purpose Potting Soil w/ CRF	1 cfl	70	CALL
13911	Black Gold® All Purpose Potting Soil w/ CRF	2 cfl	40	\$18.95
14941	Black Gold® Natural & Organic Potting Mix	1cfl	70	\$11.95
14940	Black Gold® Natural & Organic Potting Mix	2 cfl	40	\$18.95

## FAFARD® RETAIL PRODUCTS

Fafard® is a High-quality peat-based potting soil, plant mixes, and amendments to cater to every gardener's needs, providing a diverse range of options for unique growth requirements.

ITEM	DESCRIPTION	SIZE	SKID QTY	PRICE
13875	Fafard® Natural & Organic Potting Soil	1 cfl	70	\$9.95
13364	Fafard® Ultra Outdoor Planting Mix	1 cfl	70	\$10.95

# CALL FOR PALLET OR TRUCKLOAD DISCOUNTS



GREAT FOR INDOOR & OUTDOOR PLANTING



Sunshine®



**BLACK BEAR® BIOCHAR IS A SUSTAINABLE ALTERNATIVE TO PERLITE THAT PROMOTES AERATION.**



**THE BLACK BEAR® BIOCHAR IN EACH 1.5 CUBIC FOOT BAG HAS CAPTURED 2 POUNDS OF CARBON WHICH WOULD HAVE RELEASED 7.2 POUNDS OF CO2 GREENHOUSE GAS INTO THE ATMOSPHERE.**

**CONTAINS RESILIENCE® - THE SILICON ADVANTAGE WHICH MAY IMPROVE RESISTANCE TO: WILTING, HEAVY METAL TOXICITIES, AND SALT STRESS.**

**INCLUDES A PROPRIETARY WETTING AGENT FOR EASE OF WATERING.**

**UTILIZES HIGH QUALITY CANADIAN SPHAGNUM PEAT MOSS HARVESTED FROM RESPONSIBLY MANAGED, VERIFLORA® CERTIFIED PEATLANDS.**

Another quality brand from  
**sun gro**  
HORTICULTURE

©2024 SUN GRO HORTICULTURE CANADA LTD. ALL RIGHTS RESERVED. \*SUN GRO, SUNSHINE, RESILIENCE, BLACK BEAR, AND CLIMATE CONSCIOUS GROWING MIX ARE REGISTERED TRADEMARKS OF SUN GRO HORTICULTURE CANADA LTD.

# SOILS



SOMETIMES FULL PALLET MINIMUM APPLIES.

Although we would love to have all Vermont Compost products in stock, our inventory is driven by popularity. We are able to get any VC product with enough advance notice, up to two month's preferably.

## SCREENED MANURE COMPOST



This compost blend is approved for use on certified organic farms and is the basis of all of the soil mixes at Vermont Com-post. Premium compost comprised of carefully sourced, high-quality ingredients: a fully mature composted blend of bovine, equine, and avian manures, hardwood bark, late-cut hay, spoiled silage, animal bedding, and food residuals.

ITEM	DESCRIPTION	PRICE
10227	20 QUARTS	\$11.10
16103	40 QUARTS	\$19.55
11638	2 YARD SLING	\$565.00

## FORT LIGHT



Made for organic growers who want a compost-based growing mix. Uses include seed germination, transplanting vegetable and flower starts, and transplanting houseplants.

ITEM	DESCRIPTION	PRICE
4354	20 QUARTS	\$17.65
16021	45 QUARTS	\$34.10
4356	2 YARD SLING	\$775.00

## PERENNIAL BLEND



This blend is formulated for organic growing, in large pot, container, and bed culture where coarse texture is preferred. Recommended if you need to fill a raised bed.

ITEM	DESCRIPTION	PRICE
11637	20 QUARTS	\$12.70
4357	45 QUARTS	\$25.50
4358	2 YARD SLING	\$757.00

## FORT VEE



A compost-based soil with the handling and watering characteristics of a peat-perlite mix. Particularly good for growers using smaller celled flats or hanging baskets. Blended from composted manure and plant materials. Uses include seed germination, transplanting vegetable and flower starts, and transplanting houseplants.

ITEM	DESCRIPTION	PRICE
4359	20 QUARTS	\$17.65
15980	45 QUARTS	\$34.10
4361	2 YARD SLING	\$775.00

## COMPOST PLUS



Compost Plus is a nutrient-rich soil amendment that nourishes plants by providing a blend of plant-available nutrients, minerals, and organic matter. It improves soil health over time by building organic matter and supporting healthy fungal and bacterial communities.

ITEM	DESCRIPTION	PRICE
11639	20 QUARTS	\$18.10
16105	45 QUARTS	\$34.50
11640	2 YARD SLING	\$889.35





# THE SPIRIT OF Coast of Maine<sup>®</sup>

B R A N D S



Our company is energized by the same spirit that stimulates the greener gardens we work to support each day. Like the world we seek to nurture, we know that each of us has gifts to offer and lessons to learn. The complementary skills of our staff inspire our continual pursuit of the products and practices that can sustain organic growth.

**At Coast of Maine, we focus on building strong relationships with people & the planet.**

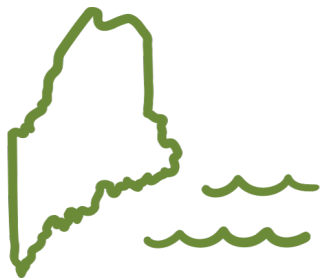

**COMMUNITY**



**DIVERSITY**



**SUSTAINABILITY**



**LOCAL**

**Our retail partners are the living link between our products and the customers gardening success.**

**We value the role and partnership each and every location plays in spreading the organic growing message.**

**FREY GROUP**<sup>LLC</sup>

Coast of Maine<sup>®</sup>

# Coast of Maine



## BAR HARBOR BLEND™

### Potting Soil

- For houseplants, flowers, veggies, herbs, & containers.
- Helps retain moisture & improve aeration.

Use for:



SKU	Description	Price
16099	16qt Bag/120	\$10.99
15469	1cf Bag/80	\$13.99
15366	2cf Bag/48	\$23.99
15342	60cf Super Sack	\$528.95



## QUODDY BLEND™

### Compost Blend

- Ready-to-use formula for growing vegetables, herbs & flowers.
- No bio-solids, municipal or home waste.

Use for:



SKU	Description	Price
4206	1cf Bag/80	\$13.99
15344	60cf Super Sack	\$586.55



## STONINGTON BLEND™

### Grower's Mix

- Rich in nutrients and formulated with amendments designed to boost budding, blooming and root development.
- Designed for high performance growing in containers. For best results, grow in 15 gallon containers.

Use for:



SKU	Description	Price
15340	1.5cf Bag/60	\$36.99
15341	60cf Super Sack	\$855.00



## STONINGTON BLEND™

### Organic Plant Food

- Promotes leafy green growth, budding, flowering & fruiting.
- For containers, vegetable gardens, flower beds.
- Great for replenishing soil between grows in your raised bed!

Use for:



SKU	Description	Price
15340	1.5cf Bag/60	\$36.99

## All Soils & Composts are available in 60cf Super Sacks



## CASTINE BLEND™

### Raised Bed Mix

- Ready-to-use formula for growing veggies, herbs & flowers. No bio-solids, municipal or home waste.

Use for:



SKU	Description	Price
15368	2cf Bag/48	\$22.99
15343	60cf Super Sack	\$495.00



## SPROUT ISLAND BLEND™

### Seed Starter

- For seed germination and rooting plant cuttings.
- Enriched with sphagnum peat moss, compost, aged bark, perlite, kelp meal, lobster shell meal, worm castings and mycorrhizae.

Use for:



SKU	Description	Price
15369	2cf Bag/48	\$29.99
15344	60cf Super Sack	\$630.95



## SCHOODIC BLEND™

### Composted Manure Blend

- Ready-to-use formula for growing vegetables, herbs & flowers.
- No bio-solids, municipal or home waste.

Use for:



SKU	Description	Price
13896	1cf Bag/80	\$11.99
15346	60cf Super Sack	\$495.00



## Aged Cedar Bark Mulch

- Promotes leafy green growth, budding, flowering & fruiting.
- For containers, vegetable gardens, flower beds.
- Great for replenishing soil between grows in your raised bed!

Use for:



SKU	Description	Price
15340	1.5cf Bag/60	\$36.99



# SOILS



## RAISED BED MIX



This Mix is designed for directly planting and sustaining heavy-feeding plants for years. Just fill your beds with this mix, plant, and water. That's all you need! We combine our microorganism-rich compost with peat moss and minerals.

ITEM	DESCRIPTION	PRICE
12718	15 qt, loose	\$9.50
13490	1 cu yd Sling	\$240.00

## SCREENED COMPOST



This on-site compost is made from locally sourced ingredients like fish, seaweed, manures, yard materials, and food scraps. The mature and weed-free product is ready to use and can improve the water-holding capacity, nutrition, and health of gardens, lawns, and landscapes. OMRI Certified

ITEM	DESCRIPTION	PRICE
12716	15 qt, loose	\$9.25
13491	1 cu yd Sling	\$224.00



# SOILS



## BM2 SEED GERMINATION



ITEM	DESCRIPTION	PRICE
2750	3 cu ft, loose	\$17.95

General-purpose high-quality plug mix for unmatched uniformity during seed germination and seedling production. Optimized aeration and water retention, reduced weight for increased volume per shipment.

## BM6 HP



ITEM	DESCRIPTION	PRICE
2879	3.0 cu ft, loose	\$14.90
15219	3.8 cu ft, bale	\$28.95

This high perlite version of BM6 is designed to provide superior aeration and drainage. This is a general use mix.

## BM4 - SOILESS W/ WOOD FIBER



ITEM	DESCRIPTION	PRICE
2751	3.8 cu ft, bale	\$26.95

A blend of Canadian sphagnum peat moss and eco-friendly NF Wood, this matrix of fibers creates a unique connective network offering high water retention and ample air space for rapid root development. Great for containers.

## BM7 COARSE BARK



ITEM	DESCRIPTION	PRICE
16066	3.0 cu ft, loose	\$18.95
3006	3.8 cu ft, bale	\$31.95

The regular BM7 is an all-purpose bark mix providing additional weight and a balanced air to water ration. The COARSE bark mix is a combination of Canadian Sphagnum peat moss, coarse bark and perlite creating ideal aeration and porosity - all while providing additional weight for the anchor. Both are well adapted for medium to large containers when extra weight is required.

## BM6 GENERAL PURPOSE



The classic peat perlite growing media is manufactured exclusively with superior ingredients under stringent quality control specifications. Provides good drainage, maintains a moderate water content between irrigations, and contains carefully sieved horticultural perlite.

ITEM	DESCRIPTION	PRICE
2880	3 cu ft, loose	\$14.95
2593	3.8 cu ft, bale	\$28.95

## RICE HULLS



An OMRI Listed amendment, serves as a multi-use replacement for perlite in greenhoused nurseries. It is less dusty and improves weed control as a top dress.

ITEM	DESCRIPTION	1-15	16+
12813	7 cu ft	\$19.00	\$18.00

## VERMICULITE & PERLITE

ITEM	DESCRIPTION	SIZE	PRICE
10334	VERMICULITE #3A FINE	4 CU FT	\$26.95
13335	VERMICULITE #A2 FINE	6 CU FT	
14277	VERMICULITE #2A MEDIUM	4 CU FT	\$28.95
2868	VERMICULITE #3A MEDIUM	6 CU FT	
2922	VERMICULITE #A4 COARSE	6 CU FT	
13413	PERLITE MEDIUM	6 CU FT	
15088	PERLITE COARSE	4 CU FT	
2867	PERLITE SUPER COARSE	6 CU FT	

**Vermiculite** enhances soil aeration and retains moisture and nutrients for faster plant growth. It also has cation exchange properties that can hold and provide essential nutrients to plants. Vermiculite is lightweight, easy to handle, and mixes well with various organic materials, fertilizers, pesticides, and herbicides.

**Perlite** is a volcanic mineral that expands significantly when heated and becomes a sterile, pH-neutral, and disease-free material with a large surface area that can hold moisture and nutrients for plant roots.



# SOILS

# FREY

## All Frey Professional Mixes are available in 60cf Super Sacks



### Professional Grower's Mix 200

- Great for seed germination, plugs, cutting propagation, hanging baskets, or small cell trays.
- Composed of canadian sphagnum peat moss, coco coir, horticultural perlite, starter charge, gypsum, wetting agent, calcitic limestone, and dolomitic limestone.
- Fine particle size and bark free for better water holding capacity.

SKU	Description	Price
15371	1.5cf Bag/60	\$23.95
7558	60cf Super Sack	\$532.95



### Professional Grower's Mix 300

- Great for bedding plants, flowering plants, hanging baskets, tropical foliage crops, cutting propagation.
- Composed of canadian sphagnum peat moss, aged pine bark, coco coir, coarse horticultural perlite, starter charge, gypsum, wetting agent, calcitic limestone, and dolomitic limestone.
- Production in 4" to 8" pots, hanging baskets, market packs, or seed starting trays.

SKU	Description	Price
15372	1.5cf Bag/60	\$23.45
16107	60cf Super Sack	\$529.85



### Professional Grower's Mix 400

- Great for growing mums, bedding plants, trees, shrubs, and raised beds.
- Composed of canadian sphagnum peat moss, coco coir, aged pine bark, organic compost, large grade sand, starter fertilizer charge, gypsum, wetting agent, calcitic limestone, and dolomitic limestone. Perlite free.
- Can be used outside for mum production or in a greenhouse.

SKU	Description	Price
15373	2cf Bag/60	\$21.95
15377	60cf Super Sack	\$495.00



### Professional Grower's Mix 500

- Great for bedding plants, flowering plants, perennials, foliage crops, and shrubs.
- Composed of canadian sphagnum peat moss, aged pine bark, coco coir, coarse horticultural perlite, starter charge, gypsum, wetting agent, calcitic limestone, and dolomitic limestone.
- Production in 8" pots up to 2 gallons.

SKU	Description	Price
15374	2cf Bag/60	\$14.75
9135	60cf Super Sack	\$495.00



### Professional Nursery Mix NX-6

- Great for trees, shrubs, natives, grasses, and ferns.
- Composed of canadian sphagnum peat moss, aged pine bark, coco coir, coarse horticultural sand, starter charge, gypsum, wetting agent, calcitic limestone, and dolomitic limestone.
- Production in 1-gallon pots and up, native grass trays, native seed propagation, or in ground plantings.

SKU	Description	Price
15376	2cf Bag/60	\$13.95
9846	60cf Super Sack	\$489.00

# CROP COVER



Embossed mulch does not expand as much when the sun shines on it and therefore it will not flop as much in the wind on a sunny day. It has superior strength for easiest removal.

**Call for pricing on 48+ Rolls**

## EMBOSSSED MULCH BLACK & CLEAR

This is a reinforced and highly durable embossed mulch that blocks weeds and prevents soil from coming into direct contact with fruit and fresh vegetables.

- Reinforced and tough to resist tearing.
- It can be laid at higher speeds.
- UV Stabilized, designed to last the duration of your growing season.
- Stretches very well and hugs tight to the bed.
- Works with practically all crop varieties.

CLEAR				
ITEM	DIMENSIONS	MIL	PRICE	
11864	4' x 4000'	1	\$129.00	
11915	4' x 4000'	0.8	\$105.00	
2920	5' x 4000'	1	\$162.50	
12566	5' x 4000'	0.8	\$131.50	
14844	6' x 2000'	1	\$110.00	
BLACK				
ITEM	DIMENSIONS	MIL	1-19 ROLLS	20+ ROLLS
3589	3' x 3000'	1	\$74.95	\$71.95
4379	4' x 2400'	1	\$81.75	\$77.50
2807	4' x 4000'	1	\$134.50	\$128.50
14843	4.5' x 4000'	1	\$156.00	\$153.00
4580	5' x 2400'	1	\$98.75	\$95.00
3609	5' x 4000'	1	\$159.00	\$155.00
14842	6' x 2400'	1	\$134.50	\$130.00
4533	4' x 2400'	1.5	\$122.50	\$118.75
4314	5' x 2400'	1.25	\$119.65	\$117.00
11863	4' x 4000'	1.25	\$162.50	\$159.00

## GREEN EMBOSSED PLASTIC

The green plastic mulch gives the heat of clear plastic, but reduces weed growth, no fumigation needed. It combines the advantages of clear and black. Ideal for early season crops. While it has less weed pressure than clear, it tends to have more than black.

ITEM	DIMENSIONS	THICKNESS	PRICE
4673	48" x 2400'	1.25	\$128.95
12901	48" x 4000'	1	\$167.95
1024	36" x 4000'	1	\$128.75

Be sure drip tape is buried in soil, especially under CLEAR Plastic as water droplets can magnify the sun & burn holes in the drip tape.

## MICRO EMBOSSED BLACK

Superior stretchability and hugs tight to the bed. The least expansion in the sun. Recommended for raised beds in sandy soils or windy areas.



ITEM	DIMENSION	THICKNESS	1-15 ROLLS	16+ ROLLS
4941	4' x 4000'	1 Mil	\$142.00	\$139.00
2829	5' x 4000'	1 Mil	\$189.00	\$185.00
14058	4' x 4000'	1.25 Mil	\$167.00	\$164.00

## EMBOSSSED WHITE ON BLACK

An ultra reflective top white layer actually decreases the soil temperature to promote growth for heat sensitive crops or warm climates, and provides additional light reflection to the underside of foliage. The black (bottom) layer stops weed growth.



ITEM	DIMENSION	THICKNESS	1-15 ROLLS	16+ ROLLS
12343	3' x 4000'	1 Mil	\$138.00	\$135.00
3592	4' x 2400'	1.25 Mil	\$147.50	\$140.00
2808	4" x 4000'	1 Mil	\$178.00	\$174.00
3800	5' x 4000'	1 Mil	\$225.00	\$219.00

## METALIZED ALUMINUM ON BLACK

Reflective metalized color on the top deters insects. The black (bottom) layer stops weed growth. The heat trap is an 8" wide black strip in center which keeps heat reduction to minimum.



ITEM	DIMENSION	HEAT TRAP?	THICKNESS	1-15 ROLLS
11834	4' x 2400'	With Heat Trap	1.25 mil	\$168.95
4823	4' x 4000'	NO Heat Trap	1 mil	\$219.95
12912	5' x 4000'	NO Heat Trap	1 mil	\$266.95
2834	6' x 2400"	NO Heat Trap	1.25 mil	\$329.95

## BLACK/WHITE SILAGE SHEET

6 MIL Silage sheets made of co-extruded low-density polyethylene, UV treated. Used to cover silage put into the ground, black on one side, white on the other.



ITEM	SIZE	PRICE
13518	24' x 100'	\$179.50
3203	32' x 100'	\$226.55
4370	32' x 150'	\$365.00
4373	40' x 100'	\$289.50
13989	50' x 100'	\$295.00
4248	50' x 150'	\$485.00



# CROP COVER

## BIOGUARD BIODEGRADABLE MULCH FILM



100% Biodegradable and compostable mulch film. Made of Mater-Bi, a starch based material. Novamont produces Mater-Bi with renewable resources such as starches from different non-GMO crops: corn & other cereals, potatoes and vegetable oils. Mater-Bi complies with international biodegradation and environmental standards, such as EN 13432 by Vinçotte and ASTM D6400 by BPI, which guarantee complete degradation in soil without any toxic residues. Not OMRI listed due to carbon black.

The degradation rate depends on film thickness, climate, and soil type. Starts breaking approximately 4-5 months on .6 mil, and 5-6 months on .8 mil. The manufacturer does not guarantee the film's life span due to different conditions such as non-compliance with laying and usage conditions, climatic conditions, etc. Lay relatively loose, and after a few hours or by the next day the mulch tightens and clings to the soil bed.

ITEM	DIMENSION	MIL	PRICE
13467	3' x 4000' .6 mil Black	0.6	\$169.75
10458	4' x 2400' Black	0.6	\$138.95
4530	4' x 4000' Black	0.6	\$239.95
4914	5' x 4000' Black	0.6	\$295.00
11983	4' x 4000' Black	0.8	\$344.25
15143	2' x 4000' Grey/Black	0.6	\$268.75
12580	4' x 4000' White/Black	0.6	\$365.00

## ECO-ONE OXO-DEGRADABLE

Environmentally sound degradation. Laboratory studies indicate that this degradable plastic breaks down into CO<sub>2</sub>, H<sub>2</sub>O, and biomass without toxic residues. Degrades fully both above and below soil. Avoid excessive tension when laying and plant immediately after laying.

Liability from the manufacturer is limited to product defects to the extent of the value of the film. The breakdown period can vary depending on the conditions. **This film will break down faster in direct sunlight.** We primarily recommend this film for crops where the foliage is casting shade over the film, such as vine crops.

### STANDARD LIFESPAN STARTS DEGRADING IN 3 - 4 MONTH.

ITEM	DIMENSION	THICKNESS	COLOR	1-9 ROLLS	10+ ROLLS
3808	4' x 8000'	0.5 mil	Black	\$310.00	\$305.00

### EXTENDED LIFESPAN, STARTS DEGRADING IN 5 - 6 MONTH

15337	4' x 8000'	.06 mil	Black	\$359.00	\$355.00
-------	------------	---------	-------	----------	----------

## CLEAR ECO-ONE FOR SWEET CORN

If you grow sweet corn under plastic, here's an option you don't want to miss. About 30-40 days after planting, or when the corn is 4-6 inches high, the plastic should start breaking up. You may have to slit it, depending on the weather. The advantage is that if the corn gets too high, you slit it and let it lay. At that point it keeps on putting heat in the soil.

ITEM	DIMENSION	MIL	1-9	10+
15860	48" x 9000'	0.4	\$259.00	\$255.00
15861	54" x 9000'	0.4	\$286.45	\$280.00
15862	60" x 9000'	0.4	\$319.45	\$310.00



# CROP COVER

## DEWITT FLOATING ROW COVER 0.55 OZ/SQ YD



Our lightest weight cover is 10% heavier than most competitors.

**Seams are sewn for strength and durability**

- 85% Light Transmission
- Protects to 30°-31°F

ITEM	SIZE	OZ/SQYD	PRICE
10198	7' x 500'	0.55	\$63.95
4617	7' x 1000'	0.55	\$119.55
4614	10' x 500'	0.55	\$86.95
4657	14' x 1000'	0.55	\$249.75
4658	20' x 1000'	0.55	\$439.75
10280	30' x 1000'	0.55	\$669.75
3600	40' x 1000'	0.55	\$779.75
10212	50' x 500'	0.55	\$595.00

## DEWITT FLOATING ROW COVER 1.0 OZ/SQ YD



This DeluxePlus row cover is close to twice as heavy as the 0.55 oz, for almost twice the frost protection. Good for strawberries and to extend fall harvests. It can usually be used for two seasons.

**Seams are sewn for strength and durability**

- 70% Light Transmission
- Protects to 28°-30°F

ITEM	SIZE	OZ/SQYD	PRICE
11727	7'x500'	1	\$128.95
12014	7' x 1000'	1	\$222.95
12753	10' x 500'	1	\$163.25
12435	14' x 500'	1	\$295.00
12902	14' x 1000'	1	\$576.75
11889	20' x 1000'	1	\$695.00
15303	27' x 800'	1	\$824.95
12015	39' x 800'	1	\$1,055.00
11903	50' x 500'	1	\$985.00

## PERFORATED ROW COVER

This film keeps a very hot environment in early spring, acting as a mini greenhouse. 3/8" Dia. Holes provide a method of venting. 1.1 mil smooth plastic.

**Note:** White is cooler than clear.

ITEM	SIZE	1-9	10+
4534	6' x 2,000' Clear Perforated	\$139.00	\$135.00
14862	6' x 2,000' White Perforated	\$143.95	\$138.00

## TYPAR® T-518 ROW COVER, 1.25 OZ/SQ YD

A strong, heavy (1.25 oz./sq. yd.) spunbonded polypropylene frost protection fabric. Seams are sewn for strength and durability. Light transmission : 70%. Frost protection: 5-6 +. Superior strength, lasts for 4+ years. An excellent choice for most crops and seasons. Can also be custom ordered any length and width (in 5' increments) required to cover a specific area. All sizes drop ship from Roanoke Rapids, NC. Allow 2 weeks for delivery. **We can supply your Typar® needs, but freight will be additional.**

LENGTH	15' WIDE	30' WIDE	45' WIDE	60' WIDE
50'	<h1>CALL FOR QUOTE</h1>			
100'				
150'				
200'				
250'				
300'				
350'				
400'				
450'				
500'				

## ANCHOR BAGS

These anchor bags can be filled with sand, dirt, or gravel to secure row cover. For plastic bags, use cable ties to close Woven bags are more puncture resistant.



ITEM	SIZE	PRICE
4579	12" x 24" 6 mil Black Plastic Anchor Bags, UV treated	250/Case \$105.95
4672	14" x 26" Woven Black Polypropylene Anchor Bags, UV treated, with tie string	100/Pack \$34.95

## PRE-ARCHED WIRE HOOPS

Heavy-duty wire hoops made from 3/16" high-tensile steel wire. Precut and pre-arched.

Call for price on full skid of 30 bundles.



ITEM	SIZE	1-9	10+
4660	64" Wire Hoops, 100/bundle	\$65.50	\$62.95
3469	76" Wire Hoops, 100/bundle	\$75.00	\$72.00

## SPRING STEEL HOOPS

Standard spring steel hoop UNBENT for use with mechanical tunnel layer. Shipping weight: 21 lbs/bundle. Full crate = 5000 pieces.

ITEM	DESCRIPTION	1-9	10-49	50+
4897	64" Spring Steel, 100/bdl	\$40.00	\$38.00	\$36.00



# CROP COVER

## PROTEKNET™ INSECT NETTING



**25 gram 0.35mm x 0.35mm white synthetic fiber.** 89% light transmission. Very pliable, great for row crops. Life expectancy: 1-2 years. **Protects against** Aphids, Armyworm, Brown Stink Bug, Cabbage Root Fly, Carrot Rust Fly, Chrysomelid, Corn Borer, Mite (Not 100%), Flea Beetles, Leafhopper, Leek Moth, Nymph, Onion Maggot, Sawfly, Seedcorn, Spotted Wing Drosophila, Squash Bug, Swede Midge (Not 100%), Tarnished Plant Bug, Thrips (Not 100%).

ITEM	DESCRIPTION	PRICE	WEIGHT
3591	83" x 328' 25 Gram	\$295.95	14 lb
12013	83" x 820' 25 Gram	\$694.35	30 lb
13608	10' x 820' 25 Gram	\$995.35	43 lb
12509	14' x 328' 25 Gram	\$549.95	26 lb
12599	14' x 820' 25 Gram	\$1393.45	30 lb

**60 gram 1.9mm x 0.95mm. Clear polyethylene.** 93% light transmission. Life span 3-5 yrs. It can be used under greenhouse curtains. **Protects against** Armyworm, Brown Marmorated Stink Bug, Cabbage Root Fly, Chrysomelid, Corn Borer, Onion Maggot, Sawfly, Seedcorn, Spotted Wing Drosophila (Not 100%), Squash Bug, Tarnished Plant Bug.

ITEM	DESCRIPTION	PRICE	WEIGHT
4098	83" x 328' 60 Gram	\$337.45	32 lb
10639	14' x 328' 60 Gram	\$660.00	64 lb

**47 grams is now available:** Life expectancy 4-5 years and it will control the Flea Beetles & Swede Midge. However, not Thrips or Aphids like the 25gram will, but more durable. **Call for pricing.**

## BIRD CONTROL NETTING

This bird control netting is ideal for crop protection against birds on berries and fruit trees. Flexible high density with 3/4" diamond pattern and 5 year life span.



ITEM	SIZE	COLOR	PRICE
3802	16' x 98'	Green	\$110.95
3835	32' x 49'	Green	\$110.95
11803	32' x 98'	Green	\$219.95
12254	21' x 328'	White	\$349.95
14849	33' x 328'	White	\$459.95
13521	49' x 328'	White	\$695.00
15419	14' x 100'	Black	\$98.50
15420	14' x 300'	Black	\$175.50
15421	14' x 500'	Black	\$275.50

## BIRD SCARE BALLOONS

Elevate at least two feet above your crop and rotate colors for best results.



ITEM	DESCRIPTION	PRICE
4173	Black	\$8.59
4172	White	\$8.59
4174	Yellow	\$8.59
12000	3 Pack	\$22.95

## BIRD SCARE BALLOONS

Deters birds with flashy appearance and noisy crackle.



ITEM	DESCRIPTION	PRICE	5+
12001	Bird Scare Tape, 1 1/4" x 290' Roll	\$7.95	\$7.59
15214	Bird Scare Tape, 3/4" x 100' Holographic	\$8.49	\$7.45



# CROP COVER



## BLACK WOVEN GROUND COVER

This UV-stabilized woven cloth exhibits exceptional strength, surpassing traditional sheet plastic materials. Constructed from woven polypropylene fabric, it offers permeability to both air and water while effectively preventing weed growth. Weighing between **3.2 and 3.3 oz. per square yard**, it features stripes at one-foot intervals.

ITEM	SIZE	1-5	6+	WEIGHT
14346	3' x 300'	\$43.95	\$39.00	25 lb
14347	4' x 300'	\$54.95	\$51.95	33 lb
14348	6' x 300'	\$79.50	\$77.50	50 lb
13750	8' x 300'	\$109.95	\$106.95	25 lb
2996	10.5' x 300'	\$138.95	\$132.95	87 lb
14351	15.5' x 300'	\$216.00	\$195.00	130 lb

## STEEL SOD STAPLES

To secure woven ground covers.

ITEM	DESCRIPTION	PRICE	5+
3640	HD Staples, 8" x 1", 8 gauge, 500/box	\$39.95	\$38.00
10293	Staples, 6" x 1", 11 gauge, 1,000/box	\$45.00	\$43.00

## ULTRAWEAVE BLACK WOVEN GROUND COVER

It is popular as a weed barrier between rows of plastic mulch. Same as the black ground cover except for lighter weight at **2.2 oz./sq. yd. with stripes every foot.**

ITEM	SIZE	1-3	WEIGHT
11973	3' x 1200'	\$127.50	66 lb
12073	4' x 900'	\$127.50	66 lb
14852	24' x 200'	\$172.00	89 lb
11656	32' x 150'	\$172.00	89 lb
14284	40' x 120'	\$172.00	89 lb

## WHITE ON BLACK WOVEN GROUND COVER

**3.8 oz./sq. Yd. Turn white up to reflect the sun and heat.**

For applications requiring cooler soil and enhanced sunlight reflection, this product is ideal. It closely resembles our black woven ground cover but boasts superior strength, featuring interwoven white and black strands. One side predominantly exhibits white strands while the reverse side primarily showcases black strands.

The black underside serves as an efficient weed blocker, inhibiting the germination of weed seeds, unlike the all-white product previously utilized.

*Upon request, we can still get 3.2 oz. white.*

ITEM	DESCRIPTION	1-5	WEIGHT
14071	3' x 300'	\$66.00	30 lbs.
14072	6' x 300'	\$128.00	60 lbs.
14073	12' x 300'	\$252.00	120 lbs.
14074	15' x 300'	\$320.00	150 lbs.



# POULTRY MANURE-BASED ORGANIC FERTILIZERS

## WHY POULTRY MANURE FERTILIZER?

Rich with high levels of macronutrients, nutrients (N-P-K) and crucial micronutrients, chicken manure-based fertilizers are a great comprehensive alternative to chemical fertilizers that safely improve the health of your lawn and garden soil.

By helping to improve overall soil structure, moisture retention and air circulation; it can be viewed not only as a highly effective fertilizer and plant food, but also as a very beneficial soil amendment.

Available in bags, totes and trailer load options

**Kreher Enterprises, LLC**  
Clarence, New York



## OUR PRODUCTS

- 5-4-3 OMRI Listed
- 4-3-10 Blend
- 8-2-2 Blend
- 7-2-6 Blend

\* Custom blends available



Visit our website for product and distributor information:

[www.kreherfertilizers.com](http://www.kreherfertilizers.com)

P: 716.512.3857



P.O. Box 278  
West Wareham, MA 02576  
(508) 273-7358  
ProgressiveGrower.com

Visit Our Location

## Progressive Grower - Wareham

81 Charlotte Furnace Road  
West Wareham, MA 02576



**Shop**

ProgressiveGrower.com



**Follow**

@progressivegrowerinc



**Follow**

Progressive Grower Ag Supply

*Restricted pesticides are available only with proof of proper applicator license*